

STEEL BUILDINGS IN EUROPE

Single-Storey Steel Buildings

Part 11: Moment Connections

Single-Storey Steel Buildings

Part 11: Moment Connections

FOREWORD

This publication is part eleven of the design guide, *Single-Storey Steel Buildings*.

The 11 parts in the *Single-Storey Steel Buildings* guide are:

- Part 1: Architect's guide
- Part 2: Concept design
- Part 3: Actions
- Part 4: Detailed design of portal frames
- Part 5: Detailed design of trusses
- Part 6: Detailed design of built up columns
- Part 7: Fire engineering
- Part 8: Building envelope
- Part 9: Introduction to computer software
- Part 10: Model construction specification
- Part 11: Moment connections

Single-Storey Steel Buildings is one of two design guides. The second design guide is *Multi-Storey Steel Buildings*.

The two design guides have been produced in the framework of the European project "Facilitating the market development for sections in industrial halls and low rise buildings (SECHALO) RFS2-CT-2008-0030".

The design guides have been prepared under the direction of Arcelor Mittal, Peiner Träger and Corus. The technical content has been prepared by CTICM and SCI, collaborating as the Steel Alliance.

Contents

	Page No
FOREWORD	iii
SUMMARY	vi
1 INTRODUCTION	1
1.1 Design approach	1
1.2 Tension zone	1
1.3 Plastic distribution	4
1.4 Resistance of the compression zone	5
1.5 Resistance of the column web panel	6
1.6 Calculation of moment resistance	6
1.7 Weld design	7
1.8 Vertical shear	8
1.9 Stiffeners	9
2 JOINT STIFFNESS	10
2.1 Classification by calculation	10
2.2 Classification boundaries	11
3 BEST PRACTICE GUIDELINES FOR MOMENT CONNECTIONS	12
3.1 Eaves haunch	12
3.2 End plate	12
3.3 Stiffeners	13
3.4 Bolts	13
3.5 Apex connections	14
3.6 Welds	14
4 JOINT DESIGN TABLES	16
4.1 General	16
4.2 Main design assumptions	17
4.3 Notes to the tables	18
4.4 Apex connections	21
4.5 Eaves connections	37
REFERENCES	53

SUMMARY

This publication provides an introduction to the design process for moment-resisting bolted connections in single storey steel framed buildings. It explains that the design process is complex, involving many steps to determine the resistance of individual bolt rows in the tension zone, checking whether the resistance of the bolt group has to be reduced on account of the performance of the connected elements, and evaluating the bending resistance from the tensile resistances of the rows. To simplify design, a series of design tables for standard connections are given, for eaves and apex connections in portal frames, with haunched and un-haunched rafters.

1 INTRODUCTION

Manual design of moment-resisting bolted connections is laborious, particularly when there are several bolt rows acting in tension. Any iteration of connection geometry or connection component (such as changing the bolt setting out or bolt size) necessitates a full re-design. For these reasons, the design of moment-resisting bolted connections is generally carried out by using appropriate software.

This Section aims to provide an introduction to the verification process described in EN 1993-1-8^[1].

1.1 Design approach

The verification of a bolted moment resisting connection involves three distinct steps:

1. Determine the potential resistance of the bolt rows in the tension zone, in isolation.
2. Check whether the total tension resistance can be realised, as it may be limited by the web panel shear resistance of the column, or the resistance of the connection in the compression zone.
3. Calculate the moment resistance as the sum of the tension forces multiplied by their respective lever arms.

The key features of the approach are firstly that a plastic distribution of bolt row forces is allowed, as long as either the end plate or the column flange is sufficiently thin. The second key feature is that the complex yield line patterns in the tension zone are replaced by an equivalent, simple T-stub model which is more amenable to calculation.

1.2 Tension zone

According to EN 1993-1-8 § 6.2.7.2(6), the effective design tension resistance $F_{tr,Rd}$ at each bolt row in the tension zone is the least of the following resistances:

- Column flange bending and bolt strength ($F_{t,fc,Rd}$)
- Column web in transverse tension ($F_{t,wc,Rd}$)
- End plate bending and bolt strength ($F_{t,ep,Rd}$)
- Rafter beam web in tension ($F_{t,wb,Rd}$).

For each bolt row, the effective design tension resistance may thus be expressed as:

$$F_{tr,Rd} = \min(F_{t,fc,Rd}; F_{t,wc,Rd}; F_{t,ep,Rd}; F_{t,wb,Rd})$$

The relevant clauses of EN 1993-1-8 for the above components are given in Table 1.1.

Table 1.1 Components of the joint to determine the potential design resistance of a bolt row

Component		EN 1993-1-8 clause number
Column flange in bending	$F_{t,fc,Rd}$	6.2.6.4 and Table 6.2
Column web in transverse tension	$F_{t,wc,Rd}$	6.2.6.3
End-plate in bending	$F_{t,ep,Rd}$	6.2.6.5 and Table 6.6
Rafter web in tension	$F_{t,wb,Rd}$	6.2.6.8

The resistance for each row is calculated in isolation. The connection resistance may be limited by:

- The design resistance of a group of bolts
- The stiffness of the column flange or end plate, which may preclude a plastic distribution of tension forces
- The shear resistance of the column web panel
- The resistance in the compression zone.

Because the tension resistance of a row may be limited by the effects of forces in other rows in the bolt group, the effective design tension resistances are considered to be potential resistances – their full realisation may be limited by other aspects of the design.

The potential design tension resistance $F_{t,r,Rd}$ for each bolt row should be determined in sequence, starting from the furthest bolt row from the centre of compression (with the maximum lever arm). In accordance with § 6.2.7.2(4), the resistance of any bolt rows closer to the centre of compression are ignored when calculating the resistance of a specific bolt row, or group of rows.

Subsequent rows are verified both in isolation and also as part of a group in combination with rows above. The resistance of row 2 is therefore taken as the lesser of:

- the resistance of row 2 acting alone, and
- the resistance of rows 1 and 2 acting as a group minus the resistance already allocated to row 1.

Row 1 is furthest from the centre of compression, and rows are numbered sequentially.

A stiffener in the column, or in the rafter, disrupts any common yield line pattern, which means that groups containing a stiffener need not be verified on that side. In a detail with an extended end plate, such as in Figure 1.1, the flange of the rafter means that there cannot be a common yield line pattern around the top two bolt rows in the end plate. On the column side, however, a common yield line pattern around the top two rows is possible, and must be verified.

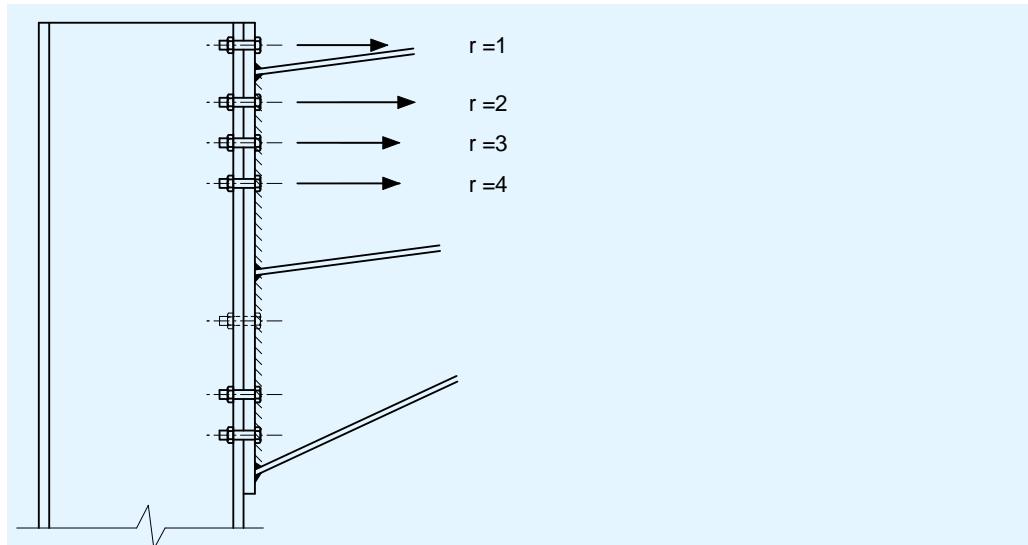

Figure 1.1 Extended end plate in a haunched eaves connection

1.2.1 End plate and column flange in bending

When determining the potential tension resistance of the end plate in bending, $F_{t,ep,Rd}$ and the column flange in bending, $F_{t,fc,Rd}$, EN 1993-1-8 converts the real yield line patterns into an equivalent T-stub. Generally, a number of yield line patterns are possible – each with a length of equivalent T-stub. The shortest equivalent T-stub is taken. When bolts are located adjacent to a stiffener, or adjacent to the rafter flange, the increased resistance of the flange or end plate is reflected in a longer length of equivalent T-stub. Bolts adjacent to an unstiffened free edge will result in a shorter length of equivalent T-stub.

Effective lengths of equivalent T-stubs ℓ_{eff} are given in Table 6.4 of EN 1993-1-8 for unstiffened flanges, in Table 6.6 for unstiffened end plates and in Table 6.5 for stiffened flanges (or end plates).

In all cases, effective lengths of equivalent T-stubs are given for individual bolt rows and for bolt rows as part of a group – the length of the equivalent T-stub for a group of bolts is assembled from the contributions of the rows within the group.

The beneficial effect of stiffeners depends on the geometry of the stiffener, the location of the bolt and the proximity to the web. This is addressed in Figure 6.11 of EN 1993-1-8, which provides an α factor used in determining the effective length of equivalent T-stub. When the bolt is sufficiently far from both web and stiffener, the stiffener has no effect – the effective length is the same as that in an unstiffened zone.

Once the effective length of T-stub has been determined, the resistance of the T-stub is calculated. Three modes, as illustrated in Figure 1.2, are examined:

- Mode 1, in which the flange of the T-stub is the critical feature, and yields in double curvature bending
- Mode 2, in which the flange and the bolts yield at the same load
- Mode 3, in which the bolts are the critical component and the resistance is the tension resistance of the bolts.

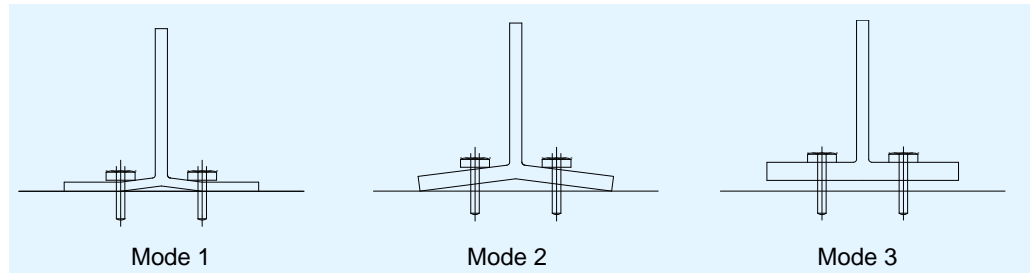

Figure 1.2 Behaviour modes of an equivalent T-stub

The expressions to calculate the resistance in the different modes are given in Table 6.2 of EN 1993-1-8.

1.2.2 Column web in transverse tension

The design resistance of an unstiffened column web in transverse tension is given by expression 6.15 in EN 1993-1-8, and is simply the resistance of a length of web, with a reduction factor ω for the interaction with shear in the column web panel. For bolted connections, § 6.2.6.3(3) states that the length of web to be assumed at each row, or for each group of rows, is equal to the length of the equivalent T-stub determined for that row (or group of rows).

1.2.3 Beam web in tension

The design resistance for a beam web in tension is given by § 6.2.6.8 and is the same as that for the column web in transverse tension, (see Section 1.2.2), but without an allowance for shear. The length of the beam web in tension is taken to be equal to the length of the equivalent T-stub determined for that pair (or group) of bolts.

1.3 Plastic distribution

A plastic distribution of forces in bolt rows is permitted, but this is only possible if the deformation of the column flange or end plate can take place. This is ensured by placing a limit on the distribution of bolt row forces if the critical mode is mode 3, because this failure mode is not ductile.

According to § 6.2.7.2(9) of EN 1993-1-8, this limit is applied if the resistance of one of the previous bolt rows is greater than $1,9 F_{t,Rd}$, where:

$F_{t,Rd}$ is the tensile resistance of a single bolt

The limit is applied by reducing the resistance of the row under consideration, to a value $F_{t,Rd}$, such that:

$F_{t,Rd} \leq F_{t,Rd} h_r / h_x$, where:

$F_{t,Rd}$ is the design tension of the furthest row from the centre of compression that has a design tension resistance greater than $1,9 F_{t,Rd}$

h_x is the lever arm from the centre of compression to the row with resistance $F_{t,Rd}$

h_r is the lever arm from the centre of compression to the row under consideration.

The effect of this limitation is to apply a triangular distribution of bolt row forces.

1.4 Resistance of the compression zone

1.4.1 General

The design resistance in the compression zone may be limited by:

- The resistance of the column web ($F_{c,wc,Rd}$), or
- The resistance of the beam (rafter) flange and web in compression ($F_{c,fb,Rd}$).

The relevant clauses of EN 1993-1-8 are given in Table 1.2.

Table 1.2 Joint Components in compression

Component		EN 1993-1-8 clause number
Resistance of column web	$F_{c,wc,Rd}$	6.2.6.2
Resistance of the beam (rafter) flange and web	$F_{c,fb,Rd}$	6.2.6.7

1.4.2 Column web without a compression stiffener

Ideally, stiffeners in the column should be avoided, as they are expensive and can be disruptive when making connections in the minor axis. However, stiffeners in the compression zone of a column are usually required, especially in a portal frame eaves connection. In a portal frame, the bending moment is large, producing a large compression force, and the column is usually an I-section with a relatively thin web.

The design resistance of an unstiffened column web subject to transverse compression is given by EN 1993-1-8, § 6.2.6.2. The design resistance is based on an effective width of web in compression, with the web verified as a strut, and with a reduction factor ω for shear and a reduction factor ρ for longitudinal compressive stress in the column.

1.4.3 Column web with a compression stiffener

The design resistance of a stiffened column subject to transverse compression may be calculated in accordance with § 9.4 of EN 1993-1-5.

1.4.4 Beam (rafter) flange and web in compression

The compression resistance of the beam flange and adjacent web in compression is given in § 6.2.6.7 of EN 1993-1-8 by:

$$F_{c,fb,Rd} = \frac{M_{c,Rd}}{(h - t_{fb})}$$

where:

h is the depth of the connected beam

$M_{c,Rd}$ is the design moment resistance of the beam cross-section, reduced if necessary to allow for shear, see EN 1993-1-1 § 6.2.5. For a haunched beam, such as a rafter, $M_{c,Rd}$ may be calculated neglecting the intermediate flange

t_{fb} is the flange thickness of the connected beam.

For haunched beams, such as those commonly used for rafters in portal frames, the depth h , should be taken as the depth of the fabricated section, and the thickness t_{fb} should be that of the haunch flange.

If the height of the beam (rafter + haunch) exceeds 600 mm the contribution of the rafter web to the design compression resistance should be limited to 20%. This means that if the resistance of the flange is $t_{fb}b_{fb}f_{y,fb}$ then:

$$F_{c,fb,Rd} \leq \frac{t_{fb}b_{fb}f_{y,fb}}{0,8}$$

1.5 Resistance of the column web panel

The resistance of the column web panel is given by § 6.2.6.1 of EN 1993-1-8, which is valid for $d/t_w \leq 69\epsilon$.

The resistance of an unstiffened column web panel in shear, $V_{wp,Rd}$ is given by:

$$V_{wp,Rd} = \frac{0,9f_{y,wc}A_{vc}}{\sqrt{3}\gamma_{M0}}$$

where:

A_{vc} is the shear area of the column, see EN 1993-1-1 § 6.2.6(3).

1.6 Calculation of moment resistance

Having calculated potential resistances in the tension zone (Section 1.2), the design resistance in the compression zone (Section 1.4) and the resistance of the column web panel in shear (Section 1.5), the effective design resistances in the tension zone may be determined.

According to EN 1993-1-8 § 6.2.7.2(7), the total design resistance in the tension zone must not exceed the design resistance in the compression zone.

Similarly, the total design resistance in the tension zone must not exceed the design resistance of the column web panel, modified by a transformation parameter, β . This is expressed as:

$$\sum F_{t,Rd} \leq V_{wp,Rd}/\beta$$

The transformation parameter, β is taken from § 5.3(7), and may be taken from Table 5.4 as 1.0 for one-sided connections.

If either the resistance in the column web panel or in the compression zone is less than the total design resistance in the tension zone, the resistances in the tension zone must be reduced.

The resistance of the bolt row nearest the centre of compression is reduced as a first step, and then the next row, until the total design resistance in the tension zone is no more than the compression resistance, or the web panel shear resistance. Reducing the bolt row resistance in this way is satisfactory, as the design approach presumes a plastic distribution of bolt forces.

As an alternative to reducing the resistance in the tension zone, stiffeners can be provided to increase the design resistance of the web panel in shear, and the web in compression.

Once the effective design tension resistances have been calculated, by reducing the potential resistances if necessary, the design moment resistance of the connection can be calculated, as the summation of each bolt row tension resistance multiplied by its lever arm from the centre of compression, i.e.:

$$M_{j,Rd} = \sum_r h_r F_{tr,Rd} \quad (\text{as given in } \S 6.2.7.2 \text{ of EN 1993-1-8})$$

The centre of compression is assumed to be in line with the centre of the compression flange.

1.7 Weld design

EN 1993-1-8 § 6.2.3(4) requires that the design moment resistance of the joint is always limited by the design resistance of its other basic components, and not by the design resistance of the welds. A convenient conservative solution is therefore to provide full-strength welds to components in tension. When components are in compression, such as the bottom flange of a haunch, it is normally assumed that the components are in direct bearing, and therefore only a nominal weld is required. If the joint experiences a reversed bending moment, the weld will be required to carry some tension force, and this should be considered.

1.7.1 Tension flange welds

The welds between the tension flange and the end plate may be full strength.

Alternatively, common practice is to design the welds to the tension flange for a force which is the lesser of:

- (a) The tension resistance of the flange, which is equal to $b_f t_f f_y$
- (b) The total tension force in the top three bolt rows for an extended end plate or the total tension force in the top two bolt rows for a flush end plate.

The approach given above may appear conservative, but at the ultimate limit state, there can be a tendency for the end plate to span vertically between the beam flanges. As a consequence, more load is attracted to the tension flange than from the adjacent bolts alone.

A full strength weld to the tension flange can be achieved by:

- a pair of symmetrically disposed fillet welds, with the sum of the throat thickness equal to the flange thickness, or
- a pair of symmetrically disposed partial penetration butt welds with superimposed fillet welds, or

- a full penetration butt weld.

For most small and medium sized beams, the tension flange welds will be symmetrical, full strength fillet welds. Once the leg length of the required fillet weld exceeds 12 mm, a full strength detail with partial penetration butt welds and superimposed fillets may be a more economical solution.

1.7.2 Compression flange welds

Where the compression flange has a sawn end, a bearing fit can be assumed between the flange and end plate and nominal fillet welds will suffice. If a bearing fit cannot be assumed, then the weld must be designed to carry the full compression force.

1.7.3 Web welds

It is recommended that web welds in the tension zone should be full strength. For beam webs up to 11,3 mm thick, a full strength weld can be achieved with 8 mm leg length (5.6 mm throat) fillet welds. It is therefore sensible to consider using full strength welds for the full web depth, in which case no calculations are needed for tension or shear.

For thicker webs, the welds to the web may be treated in two distinct parts, with a tension zone around the bolts that have been dedicated to take tension, and with the rest of the web acting as a shear zone.

Tension zone

Full strength welds are recommended. The full strength welds to the web tension zone should extend below the bottom bolt row resisting tension by a distance of $1,73g/2$, where g is the gauge (cross-centres) of the bolts. This allows an effective distribution at 60° from the bolt row to the end plate.

Shear zone

The resistance of the beam web welds for vertical shear forces should be taken as:

$$P_{sw} = 2 \times a \times f_{vw,d} \times L_{ws}$$

where:

a is the fillet weld throat thickness

$f_{vw,d}$ is the design strength of fillet welds (from EN 1993-1-8, § 4.5.3.3(2))

L_{ws} is the vertical length of the shear zone welds (the remainder of the web not identified as the tension zone).

1.8 Vertical shear

Design for vertical shear is straightforward. Generally, the bolts at the bottom of the connection are not assumed to be carrying any significant tension, and are allocated to carry the vertical shear. The bolts must be verified in shear and bearing in accordance with EN 1993-1-8 Table 3.4.

1.9 Stiffeners

Components of the joint may be strengthened by providing additional material, although this means additional expense. Table 1.3 summarises the opportunities to strengthen moment resisting joints. Types of stiffeners are illustrated in Figure 1.3.

Table 1.3 Stiffeners

Stiffener type	Effect	Comments
Compression stiffener	Increases the resistance to compression	Generally required in portal frame connections.
Flange stiffener in the tension zone	Increases the bending resistance of the column flange	
Diagonal shear stiffener	Improves the column web panel resistance and also strengthens the tension flange	A common solution – connections on the minor axis may be more complicated.
Supplementary web plate	Increases the column web resistance to shear and compression	Minor axis connections are simplified. Detail involves much welding. See §6.2.6.1 of EN 1993-1-8.
End plate stiffener	Increases the bending resistance of the end plate	Should not be used – a thicker end plate should be chosen.
Cap plate	Increases the bending resistance of the flange, and the compression resistance (in reversed moment situations)	Usually provided in the column, aligned with the top flange of the rafter. Generally provided for the reversal load combination, but effective as a tension stiffener to the column flange.
Flange backing plate	Increases the bending resistance of the flange	Only effective to increase mode 1 behaviour. See EN 1993-1-8, §6.2.4.3

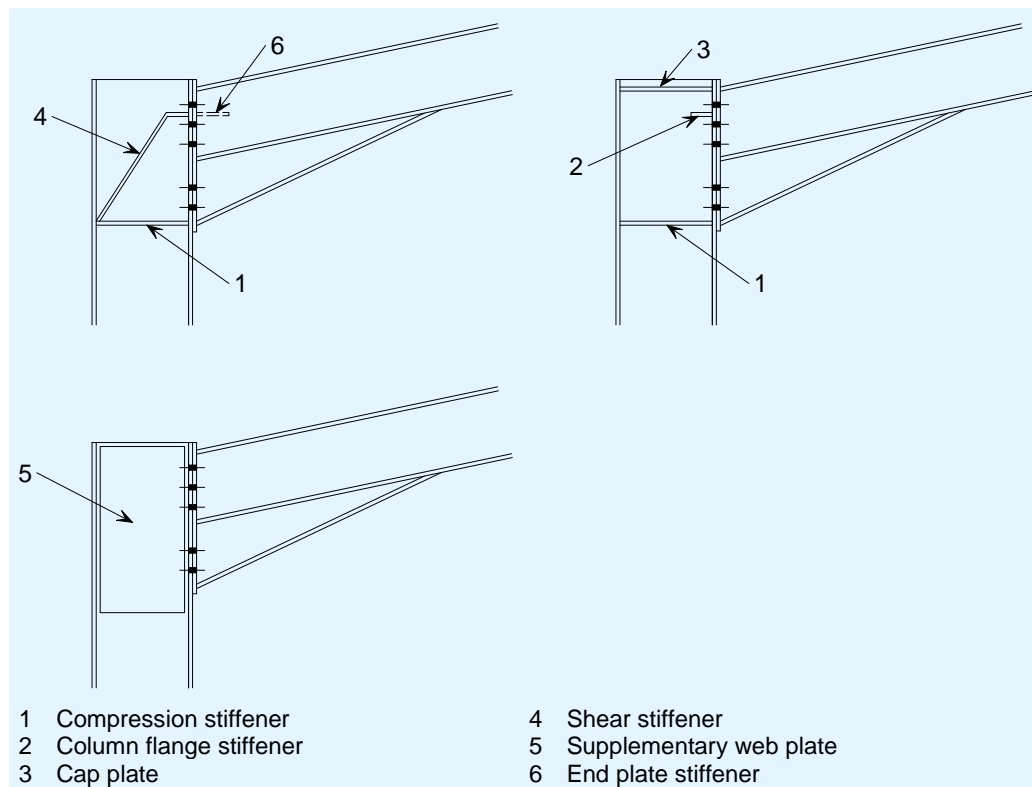

Figure 1.3 Types of stiffeners

2 JOINT STIFFNESS

EN 1993-1-8 § 5.2 requires that all joints are classified, by strength or by stiffness. Classification by strength is appropriate for plastic global analysis.

According to § 5.2.2.1(1), a joint may be classified according to its rotational stiffness, which should be calculated in accordance with the method described in Section 6.3 of EN 1993-1-8. It is recommended that software is used to calculate the initial joint stiffness. An introduction to the approach is given in Section 2.1.

In § 5.2.2.1(2) it is noted that joints may be classified on the basis of experimental evidence, experience of previous satisfactory performance in similar cases or by calculations based on test evidence. Some countries will accept classification on the basis of satisfactory performance – this may even be confirmed in the National Annex, which may point to nationally accepted design methods or joint details, and allow these to be classified without calculation.

2.1 Classification by calculation

In § 6.3.1(4) the initial stiffness, S_j is given as:

$$S_j = \frac{Ez^2}{\mu \sum_i \frac{1}{k_i}}$$

where:

E is the modulus of elasticity

μ is a stiffness ratio that depends on the ratio of the applied moment to the moment resistance of the joint

z is the lever arm, given by § 6.2.7

k_i is the stiffness of the basic joint component

2.1.1 Stiffness of basic joint components

Table 6.10 of EN 1993-1-8 identifies the basic joint components to be considered. For a one-sided bolted end plate connection, such as in a portal eaves frame, the basic joint components to be considered are given in Table 2.1.

Table 2.1 Basic joint components in a portal frame eaves connection

Stiffness coefficient	Joint component
k_1	column web panel in shear
k_2	column web in compression
k_3	column web in tension
k_4	column flange in bending
k_5	end plate in bending
k_{10}	bolts in tension

For a joint with two or more rows of bolts, the basic components for each row should be represented by a single equivalent stiffness, k_{eq} . For a beam-to-column joint with an end plate connection, this equivalent stiffness is determined using k_3 , k_4 , k_5 and k_{10} for each individual bolt row, and an equivalent lever arm. (see EN 1993-1-8, § 6.3.3.1(4)).

Table 6.11 of EN 1993-1-1 indicates how the individual stiffness coefficients should be determined.

2.2 Classification boundaries

Classification boundaries are given in EN 1993-1-8 § 5.2.2.5. They depend on the initial stiffness, $S_{j,ini}$, the second moment of area of the beam, I_b , the length of the beam, l_b and a factor, k_b that depends on the stiffness of the frame.

Joints are classified as rigid when $S_{j,ini} \geq k_b EI_b / l_b$

Thus, for a given initial stiffness $S_{j,ini}$, a minimum beam length, l_b , may be calculated such that the joint is classified as rigid. This is the basis for the minimum lengths given in Section 4.

3 BEST PRACTICE GUIDELINES FOR MOMENT CONNECTIONS

Any moment-resisting connection will involve additional expense compared to simple (shear only) details. Connections should be detailed to carry the applied forces and moments in the most economical way. This may involve providing larger member sizes, or changing the geometry of the connection, to reduce the fabrication effort involved in fitting stiffeners.

The following Sections offer guidance on appropriate detailing.

3.1 Eaves haunch

The 'haunch' in a portal frame is usually taken to mean an additional triangular cutting that is welded below the rafter beam at the connection to the column. The length of the cutting will generally be around 10% of the span, or up to 15% of the span in the most efficient elastic designs. The haunch is generally cut from the same section as the rafter, or a deeper and heavier section.

Pairs of haunch cuttings are fabricated from one length of member, as shown in Figure 3.1. If the haunch is cut from the rafter section, the maximum depth of the haunched section is therefore just less than twice the depth of the rafter section. Deeper haunches require larger sections, or fabrication from plate.

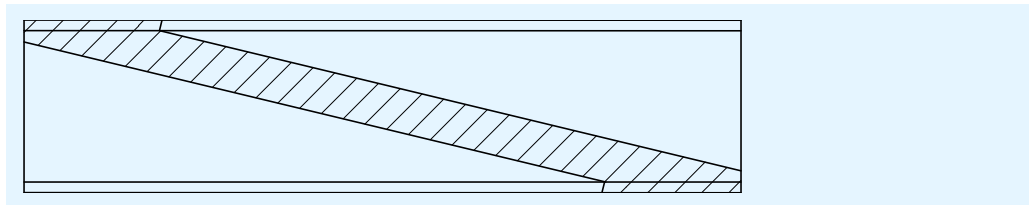

Figure 3.1 Fabrication of haunch cuttings

3.2 End plate

End plates are generally fabricated from S275 or S235 steel. For class 8.8 bolts and S275 steel, the end plate thickness should be approximately equal to the bolt diameter. Common thicknesses are:

20 mm thick when using M20 class 8.8 bolts

25 mm thick when using M24 class 8.8 bolts

The end plate should be wider than the rafter section, to allow a weld all around the flanges. The end plate should extend above and below the haunched section, to allow for the fillet welds. In the compression zone, the end plate should extend below the fillet weld for a distance at least equal to the thickness of the plate, as shown in Figure 3.2, to maximise the stiff bearing length when verifying the column in compression.

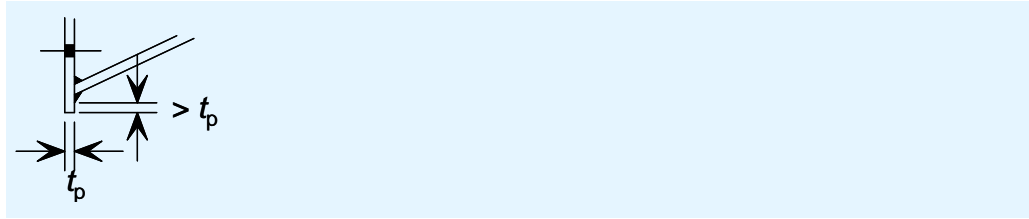

Figure 3.2 End plate – compression zone

3.3 Stiffeners

The various types of stiffener used in an eaves connection are shown in Figure 1.3. A compression stiffener is usually provided. Other stiffeners should be avoided if possible. Stiffeners to the end plate are never needed – a thicker end plate can be chosen to increase the resistance. Column flange stiffeners are used to increase the resistance of the connection. In preference to providing stiffeners, increased resistance can also be achieved by:

- Providing more bolt rows
- Extending the end plate above the top of the rafter, as shown in Figure 3.3
- Increasing the depth of the haunch
- Increasing the weight of the column section.

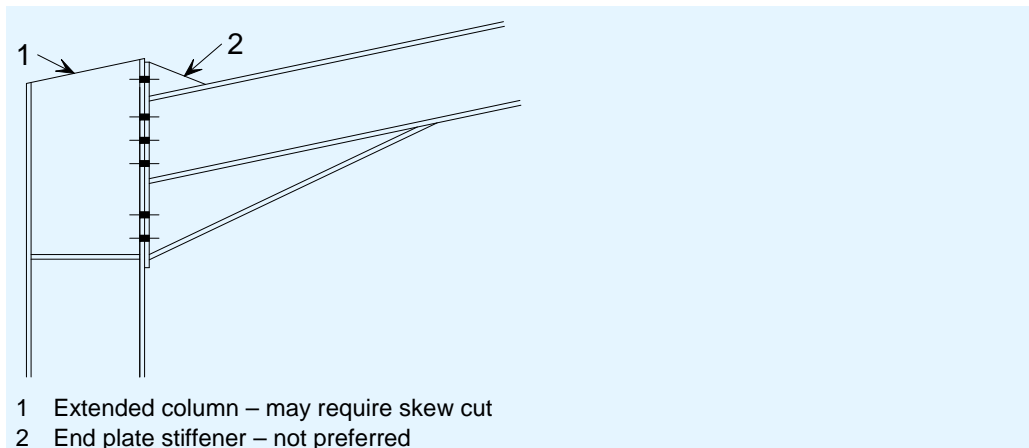

Figure 3.3 Extended end plate connection

3.4 Bolts

Bolts in moment connections are generally M20 or M24, class 8.8 or 10.9. In some countries, class 8.8 is standard. Bolts should be fully threaded, which means that the same bolts may be used throughout a building.

Bolts are generally set out at cross-centres (gauge) of 90 or 100 mm. The vertical pitch is generally 70 to 90 mm. In some countries, common practice is to have bolts regularly spaced over the complete depth of the connection. In other countries there may be a significant distance between the ‘tension’ bolts and the ‘shear’ bolts. EN 1991-1-8 does not preclude either detail. Maximum bolt spacings are given in the Standard to ensure components do not buckle

between connectors, but this behaviour does not occur in end plate connections.

Preloaded bolts are not required in portal frame connections.

3.5 Apex connections

A typical apex connection is shown in Figure 3.4. Under gravity loads the bottom of the haunch is in tension. The haunch may be fabricated from the same section as the rafter, or may be fabricated from plate.

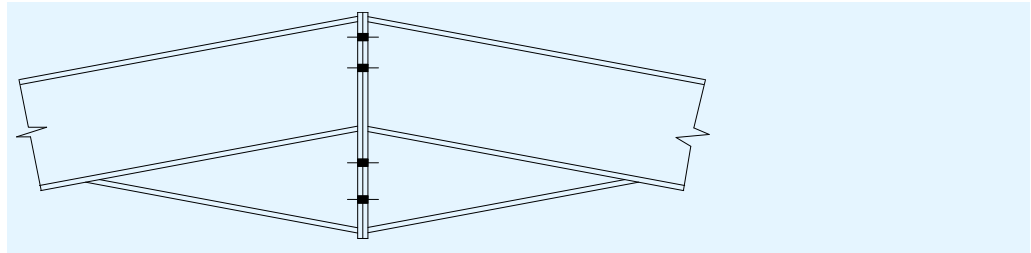

Figure 3.4 Typical apex connection

For modest structures and small bending moments, the apex detail may simply have a stiffening plate, as shown in Figure 3.5, rather than a flanged haunch.

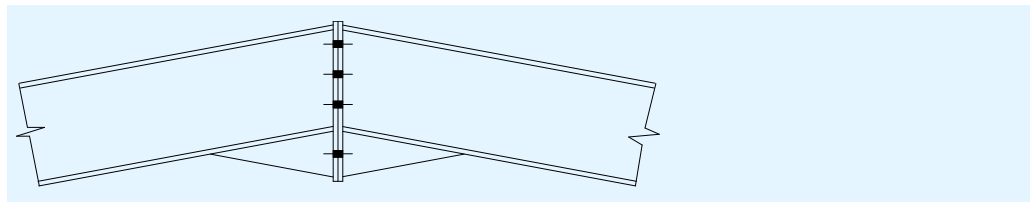

Figure 3.5 Alternative apex detail

3.6 Welds

As described in Section 1.7, full strength welds are generally required to the tension flange and adjacent to the tension bolts, as shown in Figure 3.6 for the eaves connection. The remainder of the weld to the web is designed to carry shear. Although the ‘shear’ web welds may be smaller than those in the tension zone, it is common practice to continue the same size weld for the full depth of the web.

In the compression zone, assuming that the ends of the member have been sawn, the components are in direct bearing and only a nominal weld is required. For the reversed moment design situation (with uplift due to wind), the welds at the bottom of the eaves haunch and at the top of the apex connection are in tension, and the welds should be verified for adequacy under this combination of actions.

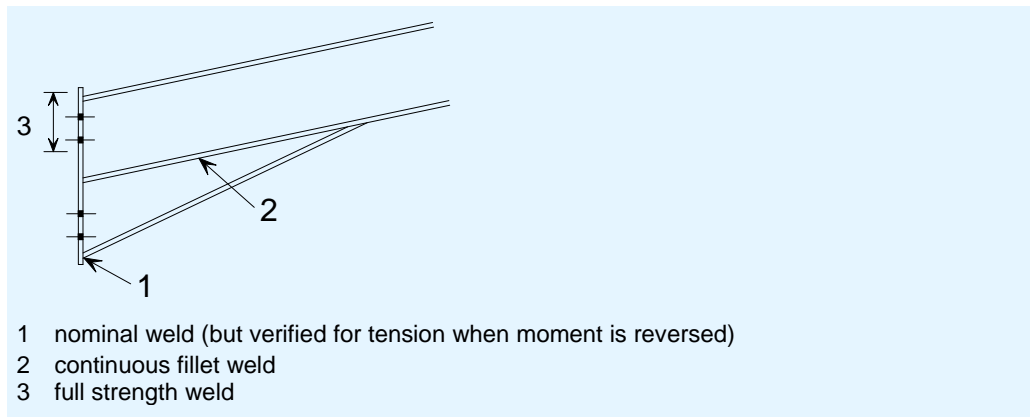

Figure 3.6 Haunch welds

The weld between the haunch cutting and the underside of the rafter is generally a continuous fillet weld. Although an intermittent weld would be perfectly adequate structurally, it is usually more convenient to provide a continuous weld.

4 JOINT DESIGN TABLES

4.1 General

This Section gives design tables for several typical configurations of moment connections in portal frames. It covers both eaves and apex connections.

Three basic profiles are covered: IPE 300, IPE 400 and IPE 500, in steel grades S235, S275 and S355. The profile sizes are generally those appropriate to span lengths of 20, 25 and 30 m respectively.

For each profile, three configurations of apex connections are tabulated for a typical bolt size and end plate thickness, and three configurations of eaves connections are tabulated for the same typical bolt size and end plate thickness. For each profile there are two additional tables, one for a different bolt class and the other for a different end plate thickness. These two additional tables are only given for apex connections without external bolts and for eaves connections with half haunch. Tables 4.1 and 4.2 give the table numbers of all the configurations.

Table 4.1 Apex connections

Profile	End plate t_p (mm)	Bolt size	Bolt class	Without external bolts	With external bolts	With external bolts and stiffener
IPE 300	15	M16	8.8	Table 4.10	Table 4.13	Table 4.14
	15		10.9	Table 4.11		
	20	8.8	Table 4.12			
IPE 400	20	M20	8.8	Table 4.15	Table 4.18	Table 4.19
	20		10.9	Table 4.16		
IPE 500	25	M24	8.8	Table 4.17	Table 4.23	Table 4.24
	25		8.8	Table 4.20		
	25		10.9	Table 4.21		
	20		8.8	Table 4.22		

Table 4.2 Eaves connections

Profile	End plate t_p (mm)	Bolt size	Bolt class	Haunch (a)	½ haunch (b)	No haunch
IPE 300	15	M16	8.8	Table 4.29	Table 4.25	Table 4.28
	15		10.9		Table 4.26	
	20		8.8		Table 4.27	
IPE 400	20	M20	8.8	Table 4.34	Table 4.30	Table 4.33
	20		10.9		Table 4.31	
	25		8.8		Table 4.32	
IPE 500	25	M24	8.8	Table 4.39	Table 4.35	Table 4.38
	25		10.9		Table 4.36	
	20		8.8		Table 4.37	

(a) The depth of the haunched beam is twice the depth of the basic profile

(b) The depth of the haunch beam is 1,5 times the depth of the basic profile

In Tables 4.10 to 4.39, the following information is given:

- A detailed sketch of the connection
- The basic parameters (profile, bolt size, bolt class, end plate thickness)
- The main design resistances (moment resistance, axial resistance, shear resistance).

The tables provide the following results:

- The design moment resistance $M_{j,Rd}^+$ for positive moment
- The minimum span length $L_{b,min}$ for the connection to be considered as 'rigid', for positive moment
- The design moment resistance $M_{j,Rd}^-$ for negative moment
- The minimum span length $L_{b,min}$ for the connection to be considered as 'rigid', for negative moment
- The design axial resistance $N_{t,j,Rd}$ for tension
- The design axial resistance $N_{c,j,Rd}$ for compression
- The maximum shear resistance $V_{j,Rd}$ for which no interaction with bending moment needs to be considered.

When a connection is subjected to a bending moment M_{Ed} and an axial force N_{Ed} , a linear interaction criterion should be applied from the above mentioned resistances:

$$N_{Ed}/N_{j,Rd} + M_{Ed}/M_{j,Rd} \leq 1,0$$

The interaction should use the appropriate design resistances, in the same direction as the internal forces:

- $N_{t,j,Rd}$ or $N_{c,j,Rd}$ for the axial force (tension or compression)
- $M_{j,Rd}^+$ or $M_{j,Rd}^-$ for the bending moment (positive or negative)

4.2 Main design assumptions

The tables have been prepared using the *PlatineX* software available on the web site www.steelbizfrance.com. This software can be freely used online and allows the designer to deal with any configuration of connections – apex or eaves connection.

The tables are based on the following design assumptions:

- Calculations according to EN 1993-1-8
- S235 end plate and stiffeners with S235 members, S275 otherwise
- Bolt classes 8.8 and 10.9
- Partial factors γ_M as recommended (not to any particular National Annex).

Sign convention:

The bending moment is positive when it generates compression stresses in the lower flange and tension stresses in the upper flanges (Figure 4.1).

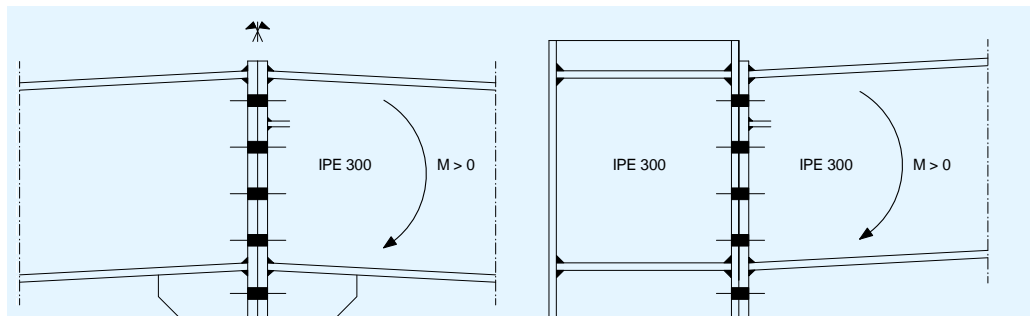

Figure 4.1: Sign convention for bending moment

4.3 Notes to the tables

4.3.1 Apex connections

Tables 4.4 to 4.6 summarize the design moment resistances for the apex connections subject to positive moments. They can be compared with the plastic moment resistance of the cross-section (Table 4.3).

Table 4.3 Plastic moment resistance of the cross section (kNm)

Profile	S235	S275	S355
IPE 300	148	173	223
IPE 400	307	359	464
IPE 500	516	603	779

Bolts outside the profile have a major influence on the moment resistance when they are in tension. The stiffener welded to the tension flange always increases the moment resistance, but not to the same degree.

The moment resistance is lower than the plastic moment of the cross-section. However this is not a problem since the member resistance is usually reduced by the buckling effects, including lateral-torsional buckling.

The minimum span length to consider the apex connection as fully rigid is relatively low. In practice, these connections will always be used for portal frames with a span length greater than this minimum value, and so can be considered rigid.

At the apex, the shear force is small and this verification will never be critical in common practice.

Table 4.4 Apex connections with S235 beams – Moment resistance (kNm)

Profile	End plate t_p (mm)	Bolt size	Bolt class	Without external bolts	With external bolts	With external bolts and stiffener
IPE 300	15	M16	8.8	75,4	118	123
	15		10.9	86,3		
	20		8.8	78,4		
IPE 400	20	M20	8.8	189	258	269
	20		10.9	210		
	25		8.8	197		
IPE 500	25	M24	8.8	358	449	472
	25		10.9	363		
	20		8.8	340		

Table 4.5 Apex connections with S275 beams – Moment resistance (kNm)

Profile	End plate t_p (mm)	Bolt size	Bolt class	Without external bolts	With external bolts	With external bolts and stiffener
IPE 300	15	M16	8.8	78,4	123,5	132,8
	15		10.9	91,7		
	20		8.8	78,4		
IPE 400	20	M20	8.8	199,7	284,3	301,2
	20		10.9	231,0		
	25		8.8	199,7		
IPE 500	25	M24	8.8	407,3	504,8	533,6
	25		10.9	421,5		
	20		8.8	360,0		

Table 4.6 Apex connections with S355 beams – Moment resistance (kNm)

Profile	End plate t_p (mm)	Bolt size	Bolt class	Without external bolts	With external bolts	With external bolts and stiffener
IPE 300	15	M16	8.8	78,4	123,5	132,8
	15		10.9	91,7		
	20		8.8	78,4		
IPE 400	20	M20	8.8	199,7	293,9	318,4
	20		10.9	231,3		
	25		8.8	199,7		
IPE 500	25	M24	8.8	426,3	577,1	620,4
	25		10.9	479,4		
	20		8.8	360,0		

4.3.2 Eaves connections

The minimum span length to consider the eaves connection as fully rigid is relatively low when a haunch is provided, and in practice these connections will always be used for portal frames with a span length greater than this minimum value. The connections may therefore be considered as rigid.

Without a haunch, the bending resistance is lower and the connection might be classified as semi-rigid. Therefore it is good practice to design the eaves connections with a haunch, so that the overall depth is at least 1,5 times the depth of the rafter.

The shear resistance of the column web is often the critical criterion.

For the eaves connections, the shear force is significant but the verification is generally not critical for the design.

Table 4.7 Eaves connections (S235 members) – Moment resistances (kNm)

Profile	End plate t_p (mm)	Bolt size	Bolt class	Haunch	½ haunch	No haunch
IPE 300	15	M16	8.8	177,2	134,7	87,4
	15		10.9		136,4	
	20		8.8		134,7	
IPE 400	20	M20	8.8	388,0	291,2	186,6
	20		10.9		293,9	
	25		8.8		291,2	
IPE 500	25	M24	8.8	683,3	511,0	327,8
	25		10.9		514,9	
	20		8.8		500,2	

Table 4.8 Eaves connections (S275 members) – Moment resistances (kNm)

Profile	End plate t_p (mm)	Bolt size	Bolt class	Haunch	½ haunch	No haunch
IPE 300	15	M16	8.8	204,1	154,3	98,9
	15		10.9		158,2	
	20		8.8		154,3	
IPE 400	20	M20	8.8	451,8	338,3	214,8
	20		10.9		341,6	
	25		8.8		338,3	
IPE 500	25	M24	8.8	795,8	593,9	379,0
	25		10.9		599,2	
	20		8.8		580,9	

Table 4.9 Eaves connections (S355 members) – Moment resistances (kNm)

Profile	End plate t_p (mm)	Bolt size	Bolt class	Haunch	½ haunch	No haunch
IPE 300	15	M16	8.8	251,9	187,4	113,6
	15		10.9		197,2	
	20	8.8	189,1			
IPE 400	20	M20	8.8	564,0	417,5	258,2
	20		10.9		435,2	
	25	8.8	420,8			
IPE 500	25	M24	8.8	1000	739,7	462,3
	25		10.9		763,7	
	20	8.8	716,4			

4.4 Apex connections

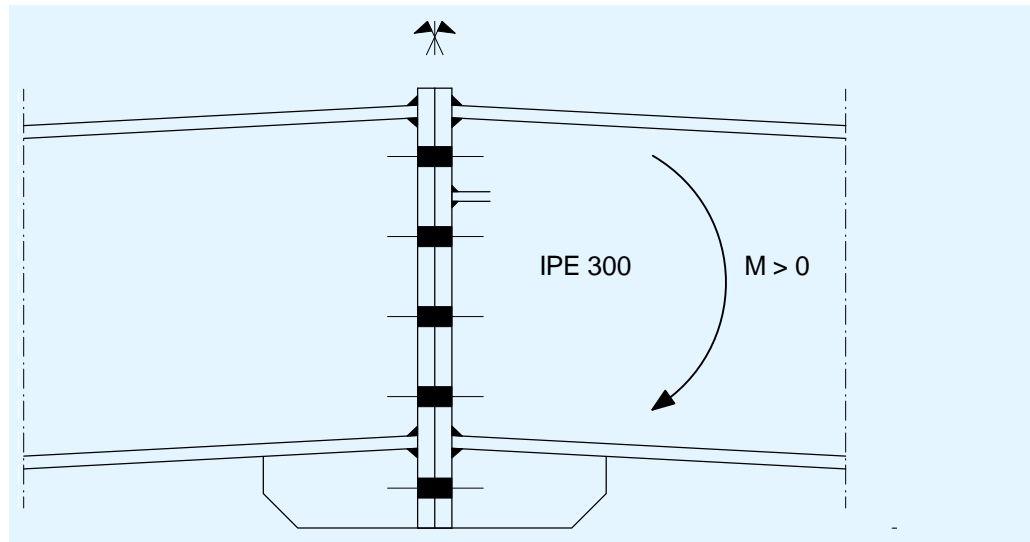
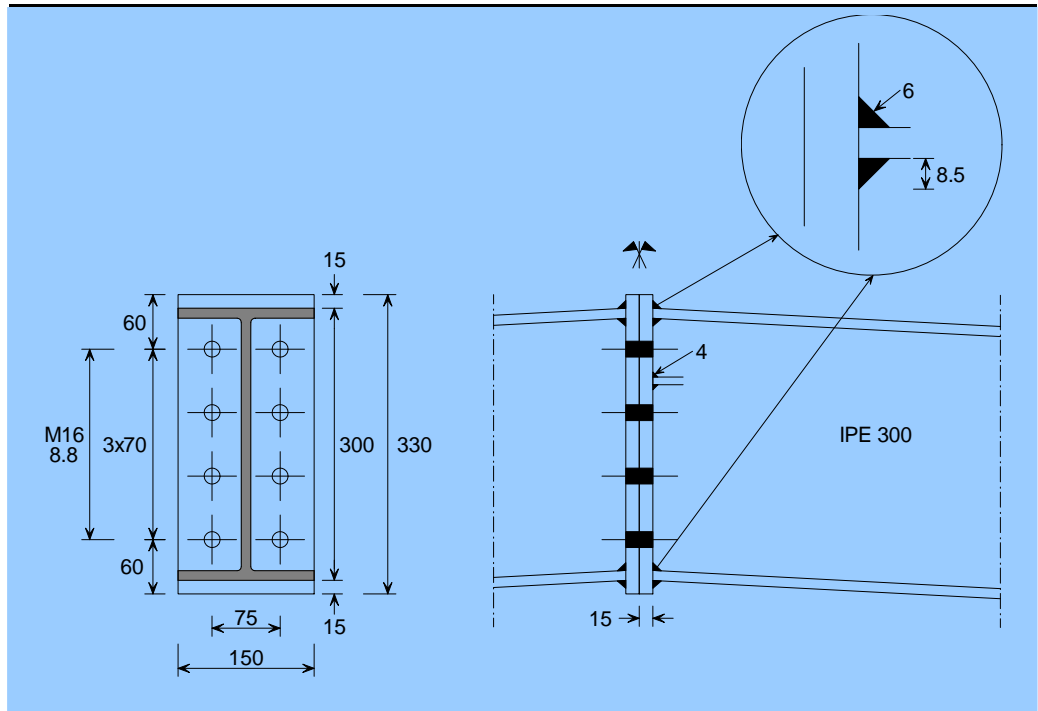

Figure 4.2 Sign convention for bending moment in apex connections

Table 4.10 Apex connection – IPE 300



Bolts M16	8.8
Hole diameter	18 mm
End plate	$t_p = 15$ mm

Beam IPE 300	S235	S275	S355
Positive moment			
Design moment resistance $M_{j,Rd}$ (kNm)	75,4	78,4	78,4
Minimum span length for 'rigid' $L_{b,min}$ (m)		6,37	
Negative moment			
Design moment resistance $M_{j,Rd}$ (kNm)	75,4	78,4	78,4
Minimum span length for 'rigid' $L_{b,min}$ (m)		6,37	
Design axial resistance			
Tension $N_{t,j,Rd}$ (kN)	567	595	595
Compression $N_{c,j,Rd}$ (kN)	1264	1480	1710
Design shear resistance $V_{j,Rd}$ (kN)		135	

Table 4.11 Apex connection – IPE 300

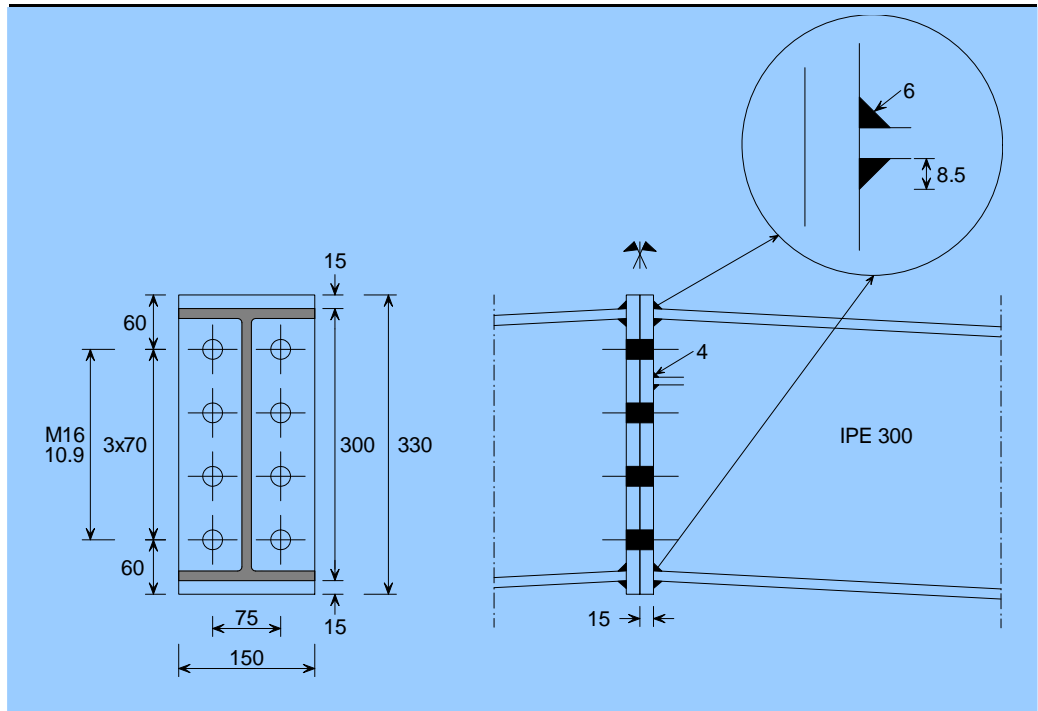

Bolts M16	10.9
Hole diameter	18 mm
End plate	$t_p = 15$ mm

Beam IPE 300	S235	S275	S355
Positive moment			
Design moment resistance $M_{j,Rd}$ (kNm)	86,3	91,7	91,7
Minimum span length for 'rigid' $L_{b,min}$ (m)		6,37	
Negative moment			
Design moment resistance $M_{j,Rd}$ (kNm)	86,3	91,7	91,7
Minimum span length for 'rigid' $L_{b,min}$ (m)		6,37	
Design axial resistance			
Tension $N_{t,j,Rd}$ (kN)	668	696	696
Compression $N_{c,j,Rd}$ (kN)	1264	1480	1710
Design shear resistance $V_{j,Rd}$ (kN)		141	

Table 4.12 Apex connection – IPE 300

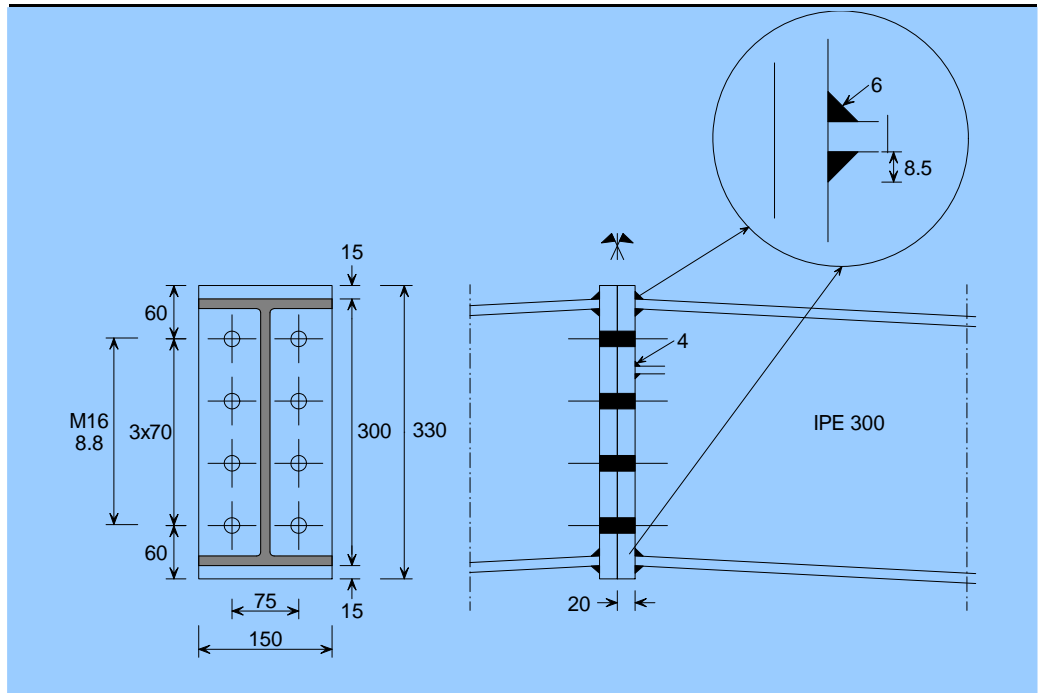

Bolts M16	8.8
Hole diameter	18 mm
End plate	$t_p = 20$ mm

Beam IPE 300	S235	S275	S355
Positive moment			
Design moment resistance $M_{j,Rd}$ (kNm)	78,4	78,4	78,4
Minimum span length for 'rigid' $L_{b,min}$ (m)		5,37	
Negative moment			
Design moment resistance $M_{j,Rd}$ (kNm)	78,4	78,4	78,4
Minimum span length for 'rigid' $L_{b,min}$ (m)		5,37	
Design axial resistance			
Tension $N_{t,j,Rd}$ (kN)	688	723	723
Compression $N_{c,j,Rd}$ (kN)	1264	1480	1710
Design shear resistance $V_{j,Rd}$ (kN)		135	

Table 4.13 Apex connection – IPE 300

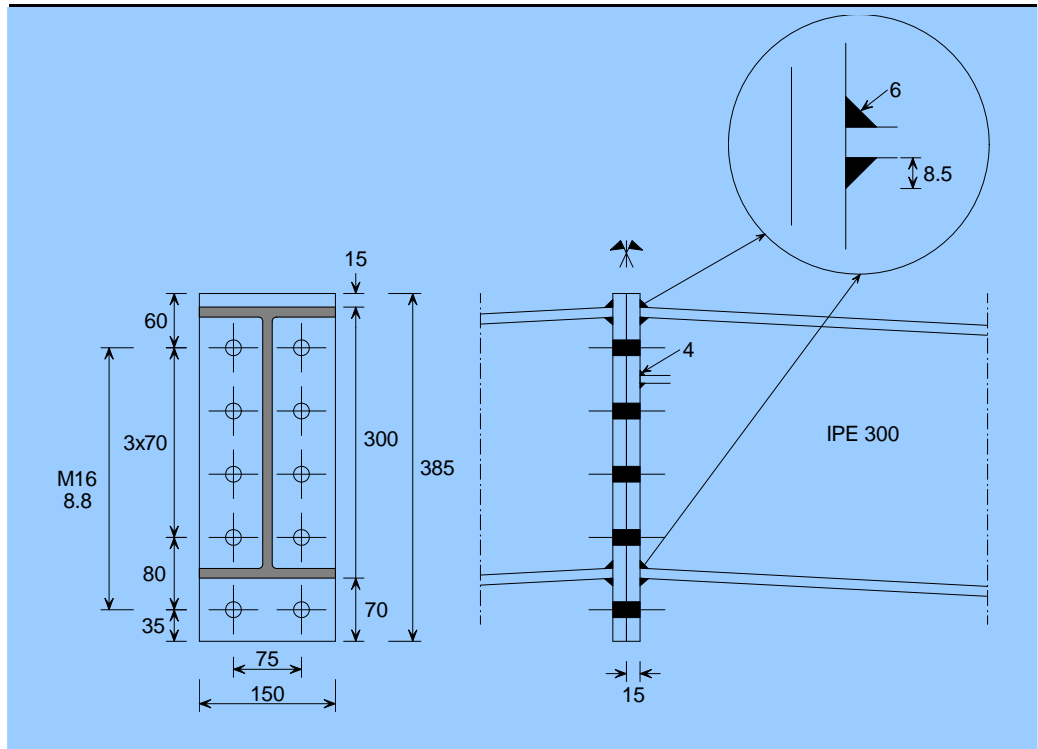

Bolts M16 8.8
 Hole diameter 18 mm
 End plate $t_p = 15$ mm

Beam IPE 300	S235	S275	S355
Positive moment			
Design moment resistance $M_{j,Rd}$ (kNm)	117,8	123,5	123,5
Minimum span length for 'rigid' $L_{b,min}$ (m)		3,34	
Negative moment			
Design moment resistance $M_{j,Rd}$ (kNm)	75,4	78,4	78,4
Minimum span length for 'rigid' $L_{b,min}$ (m)		6,37	
Design axial resistance			
Tension $N_{t,j,Rd}$ (kN)	699	732	732
Compression $N_{c,j,Rd}$ (kN)	1264	1480	1710
Design shear resistance $V_{j,Rd}$ (kN)			
		169	

Table 4.14 Apex connection – IPE 300

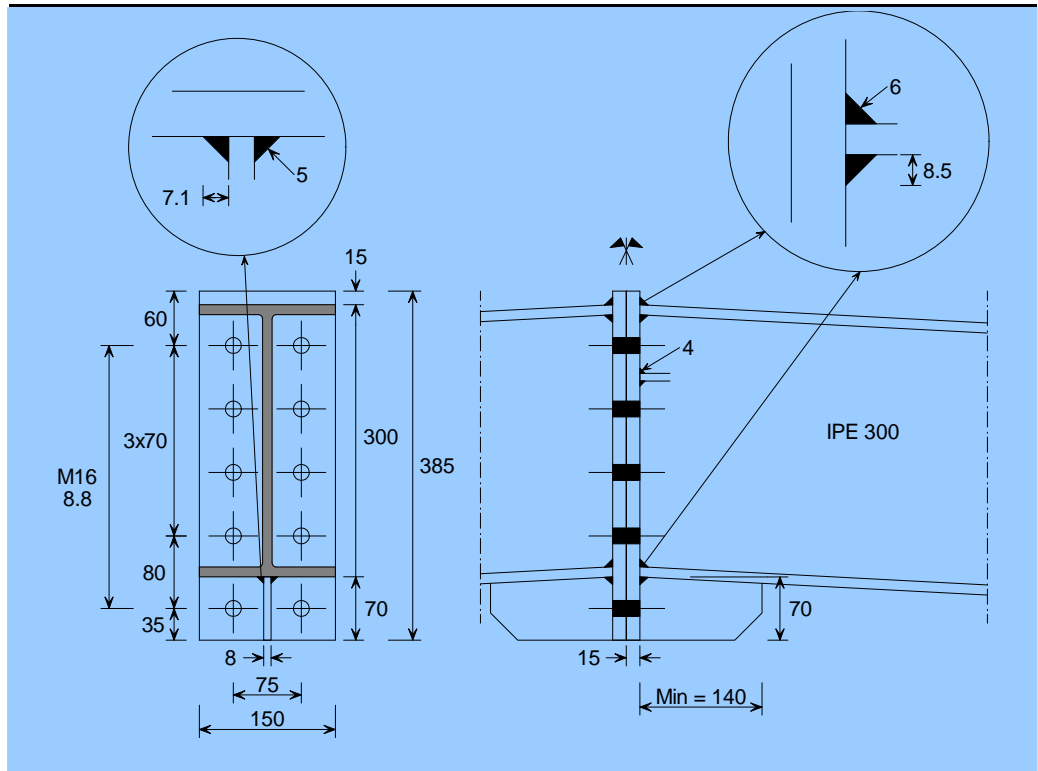

Bolts M16	8.8
Hole diameter	18 mm
End plate	$t_p = 15 \text{ mm}$
Stiffeners	$t_p = 8 \text{ mm}$

Beam IPE 300	S235	S275	S355
Positive moment			
Design moment resistance $M_{j,Rd}$ (kNm)	123,4	132,8	132,8
Minimum span length for 'rigid' $L_{b,min}$ (m)		2,90	
Negative moment			
Design moment resistance $M_{j,Rd}$ (kNm)	75,4	78,4	78,4
Minimum span length for 'rigid' $L_{b,min}$ (m)		6,37	
Design axial resistance			
Tension $N_{t,j,Rd}$ (kN)	723	761	761
Compression $N_{c,j,Rd}$ (kN)	1264	1480	1710
Design shear resistance $V_{j,Rd}$ (kN)			
		169	

Table 4.15 Apex connection – IPE 400

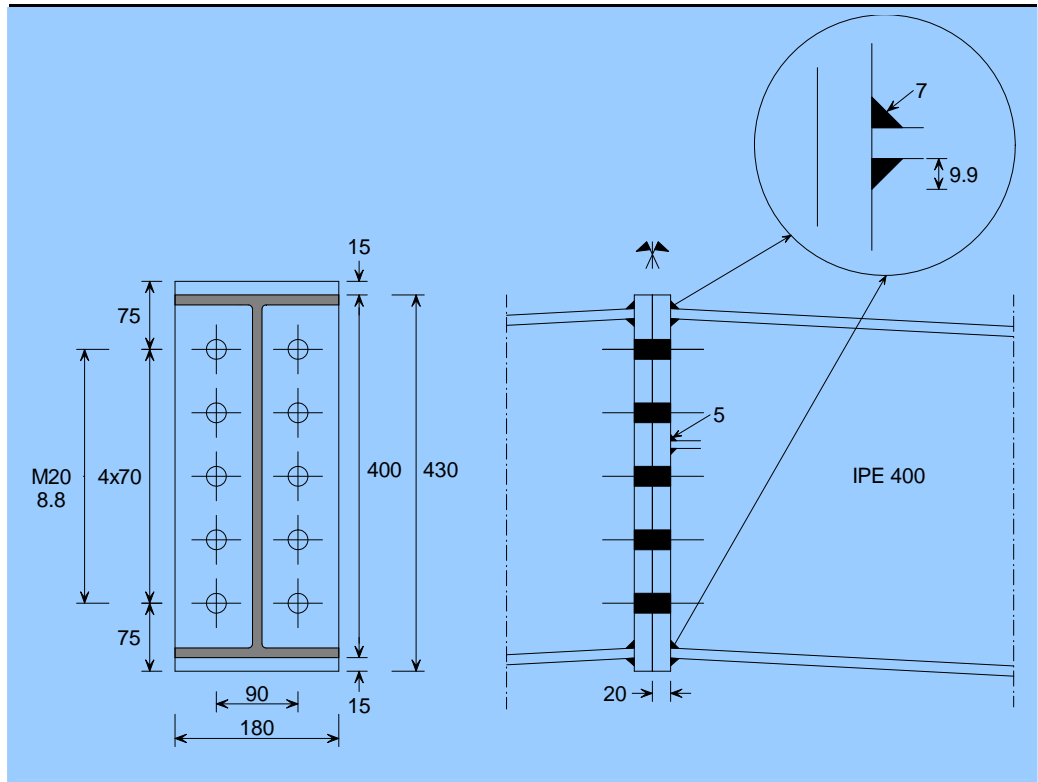

Bolts M20 8.8
 Hole diameter 22 mm
 End plate $t_p = 20$ mm

Beam IPE 400	S235	S275	S355
Positive moment			
Design moment resistance $M_{j,Rd}$ (kNm)	189,4	199,7	199,7
Minimum span length for 'rigid' $L_{b,min}$ (m)		6,36	
Negative moment			
Design moment resistance $M_{j,Rd}$ (kNm)	189,4	199,7	199,7
Minimum span length for 'rigid' $L_{b,min}$ (m)		6,36	
Design axial resistance			
Tension $N_{t,j,Rd}$ (kN)	1038	1142	1142
Compression $N_{c,j,Rd}$ (kN)	1986	2279	2553
Design shear resistance $V_{j,Rd}$ (kN)		263	

Table 4.16 Apex connection – IPE 400

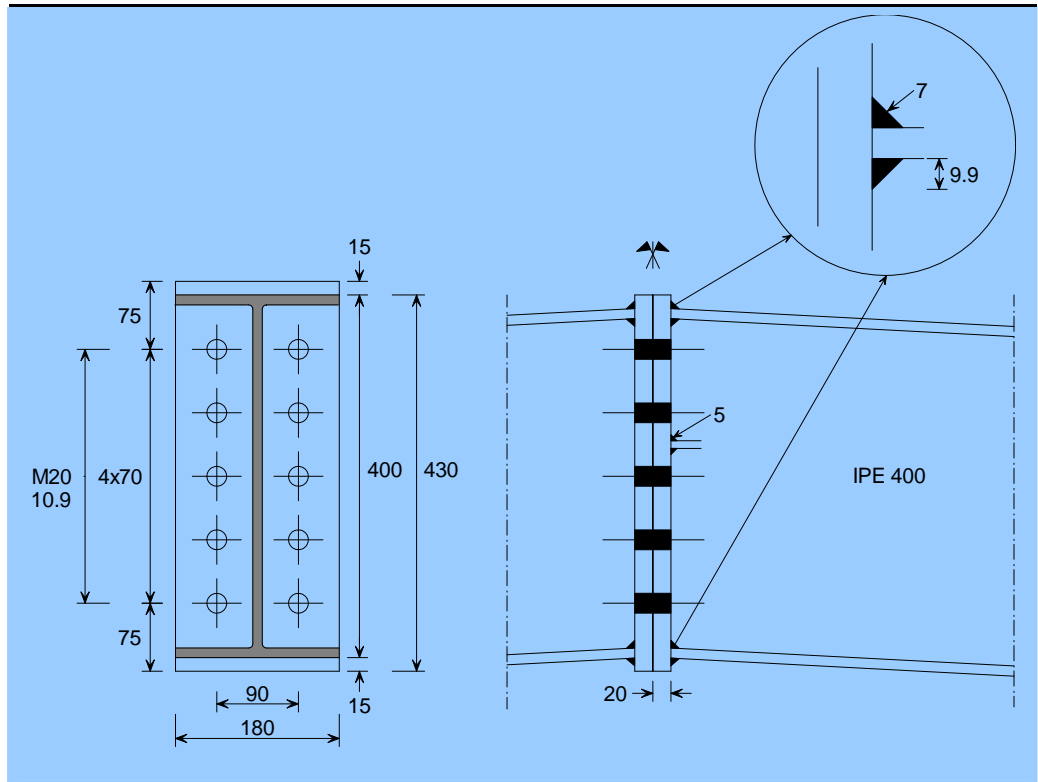

Bolts M20 10.9
 Hole diameter 22 mm
 End plate $t_p = 20$ mm

Beam IPE 400	S235	S275	S355
Positive moment			
Design moment resistance $M_{j,Rd}$ (kNm)	210,2	231,0	231,3
Minimum span length for 'rigid' $L_{b,min}$ (m)		6,36	
Negative moment			
Design moment resistance $M_{j,Rd}$ (kNm)	210,2	231,0	231,3
Minimum span length for 'rigid' $L_{b,min}$ (m)		6,36	
Design axial resistance			
Tension $N_{t,j,Rd}$ (kN)	1038	1200	1338
Compression $N_{c,j,Rd}$ (kN)	1986	2279	2553
Design shear resistance $V_{j,Rd}$ (kN)		274	

Table 4.17 Apex connection – IPE 400

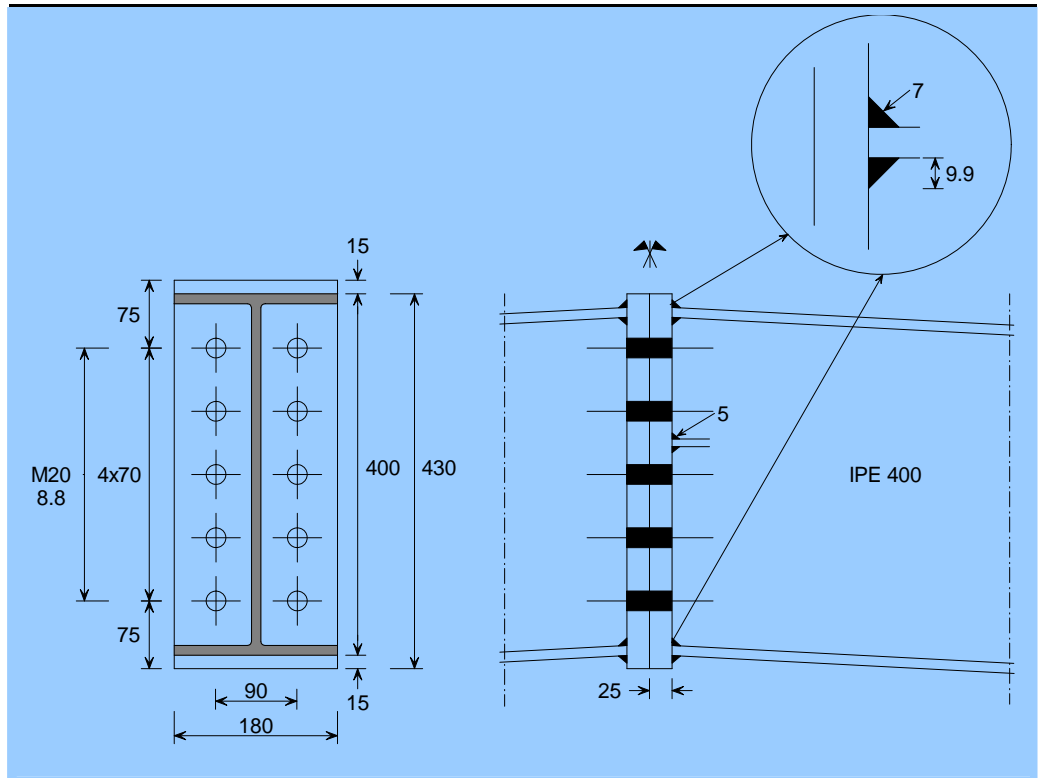

Bolts M20 8.8
 Hole diameter 22 mm
 End plate $t_p = 25$ mm

Beam IPE 400	S235	S275	S355
Positive moment			
Design moment resistance $M_{j,Rd}$ (kNm)	196,9	199,7	199,7
Minimum span length for 'rigid' $L_{b,min}$ (m)		5,61	
Negative moment			
Design moment resistance $M_{j,Rd}$ (kNm)	196,9	199,7	199,7
Minimum span length for 'rigid' $L_{b,min}$ (m)		5,61	
Design axial resistance			
Tension $N_{t,j,Rd}$ (kN)	1038	1200	1344
Compression $N_{c,j,Rd}$ (kN)	1986	2279	2553
Design shear resistance $V_{j,Rd}$ (kN)		263	

Table 4.18 Apex connection – IPE 400

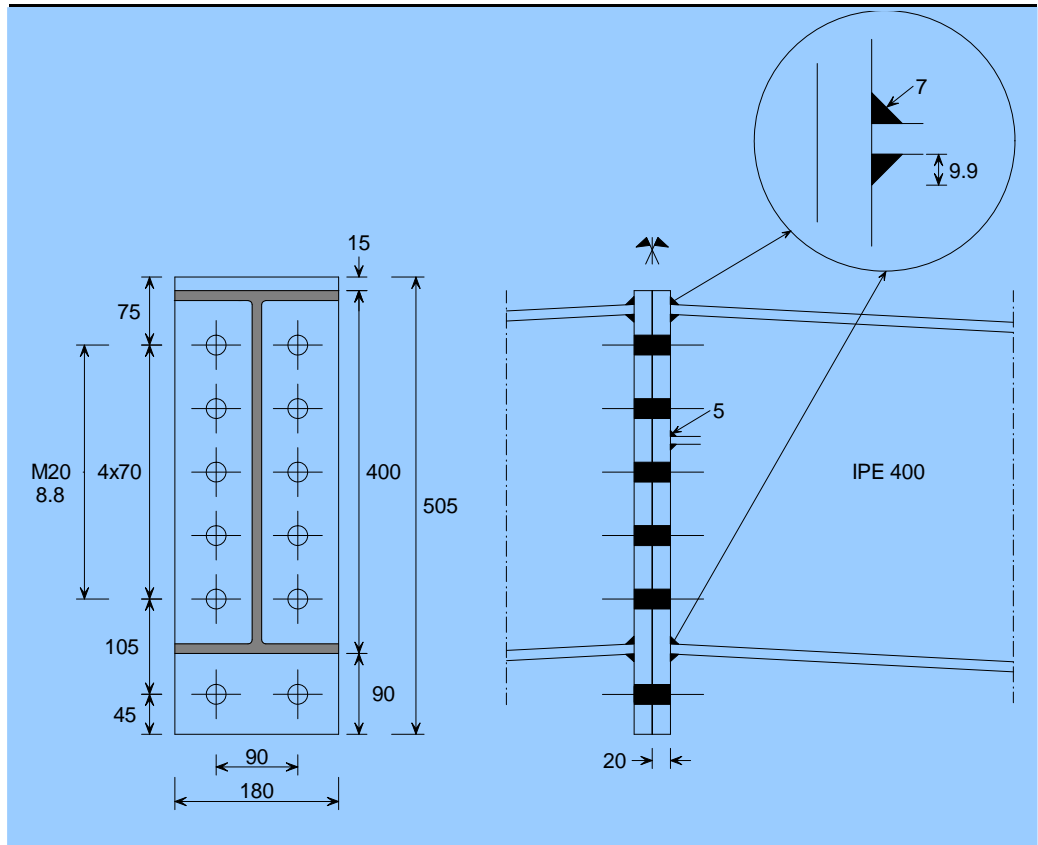

Bolts M20 8.8
 Hole diameter 22 mm
 End plate $t_p = 20$ mm

Beam IPE 400	S235	S275	S355
Positive moment			
Design moment resistance $M_{j,Rd}$ (kNm)	257,7	284,3	293,9
Minimum span length for 'rigid' $L_{b,min}$ (m)		3,72	
Negative moment			
Design moment resistance $M_{j,Rd}$ (kNm)	189,4	199,7	199,7
Minimum span length for 'rigid' $L_{b,min}$ (m)		6,36	
Design axial resistance			
Tension $N_{t,j,Rd}$ (kN)	1244	1357	1357
Compression $N_{c,j,Rd}$ (kN)	1986	2279	2553
Design shear resistance $V_{j,Rd}$ (kN)		316	

Table 4.19 Apex connection – IPE 400

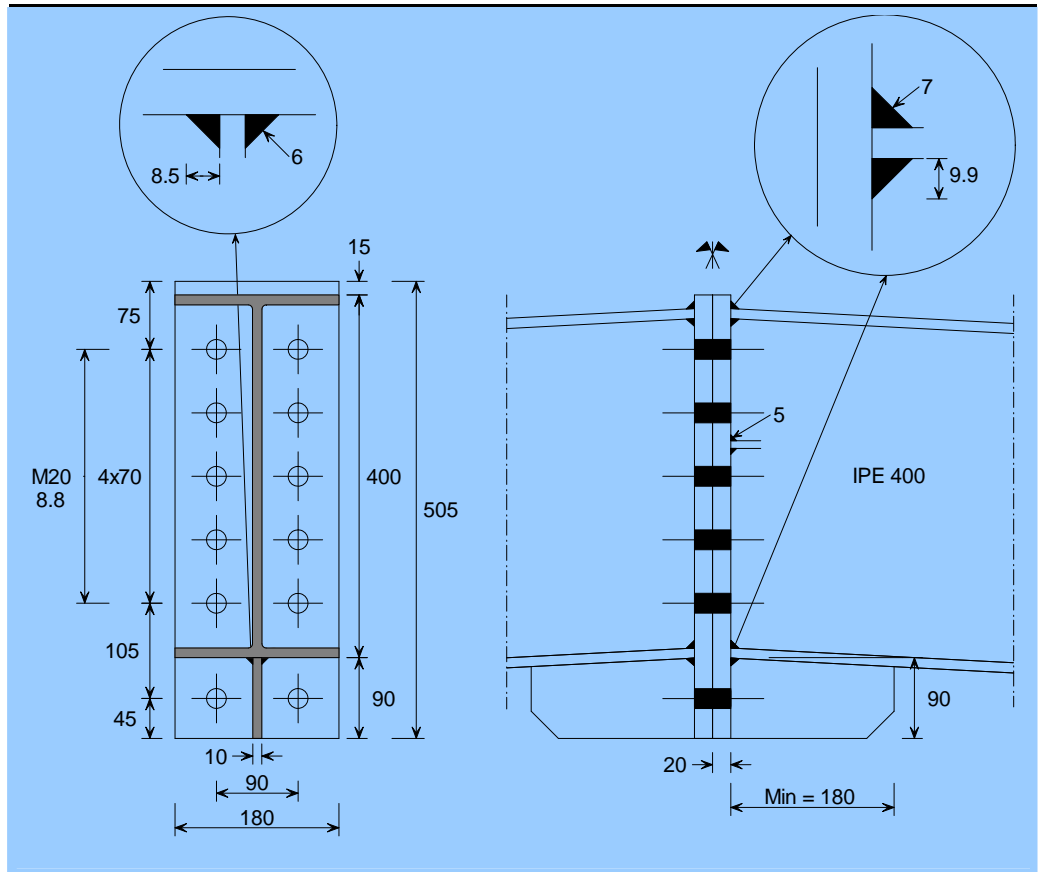

Bolts M20	8.8
Hole diameter	22 mm
End plate	$t_p = 20$ mm
Stiffeners	$t_p = 10$ mm

Beam IPE 400	S235	S275	S355
Positive moment			
Design moment resistance $M_{j,Rd}$ (kNm)	269,4	301,2	318,4
Minimum span length for 'rigid' $L_{b,min}$ (m)		3,14	
Negative moment			
Design moment resistance $M_{j,Rd}$ (kNm)	189,4	199,7	199,7
Minimum span length for 'rigid' $L_{b,min}$ (m)		6,36	
Design axial resistance			
Tension $M_{i,j,Rd}$ (kN)	1292	1413	1413
Compression $N_{c,j,Rd}$ (kN)	1986	2279	2553
Design shear resistance $V_{j,Rd}$ (kN)			
		316	

Table 4.20 Apex connection – IPE 500

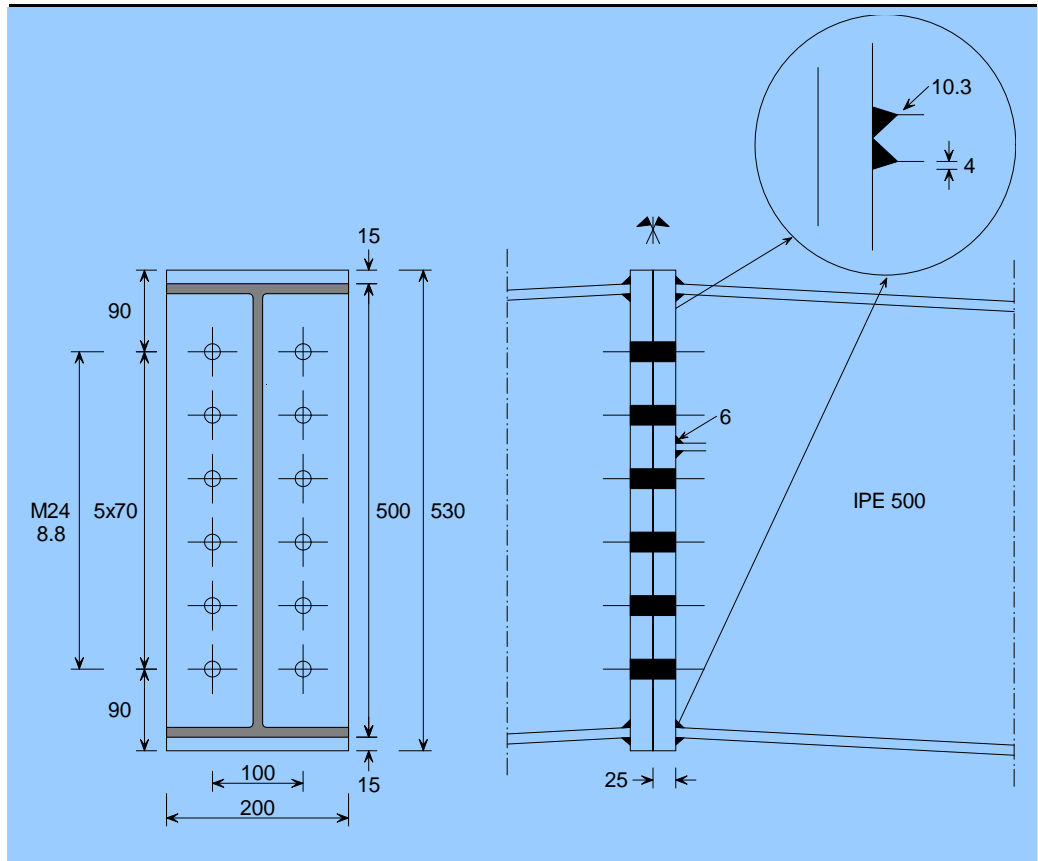

Bolts M24 8.8
 Hole diameter 26 mm
 End plate $t_p = 25$ mm

Beam IPE 500	S235	S275	S355
Positive moment			
Design moment resistance $M_{j,Rd}$ (kNm)	358,1	407,3	426,3
Minimum span length for 'rigid' $L_{b,min}$ (m)		5,62	
Negative moment			
Design moment resistance $M_{j,Rd}$ (kNm)	358,1	407,3	426,3
Minimum span length for 'rigid' $L_{b,min}$ (m)		5,62	
Design axial resistance			
Tension $N_{t,j,Rd}$ (kN)	1404	1642	1839
Compression $N_{c,j,Rd}$ (kN)	2726	3190	4044
Design shear resistance $V_{j,Rd}$ (kN)		455	

Table 4.21 Apex connection – IPE 500

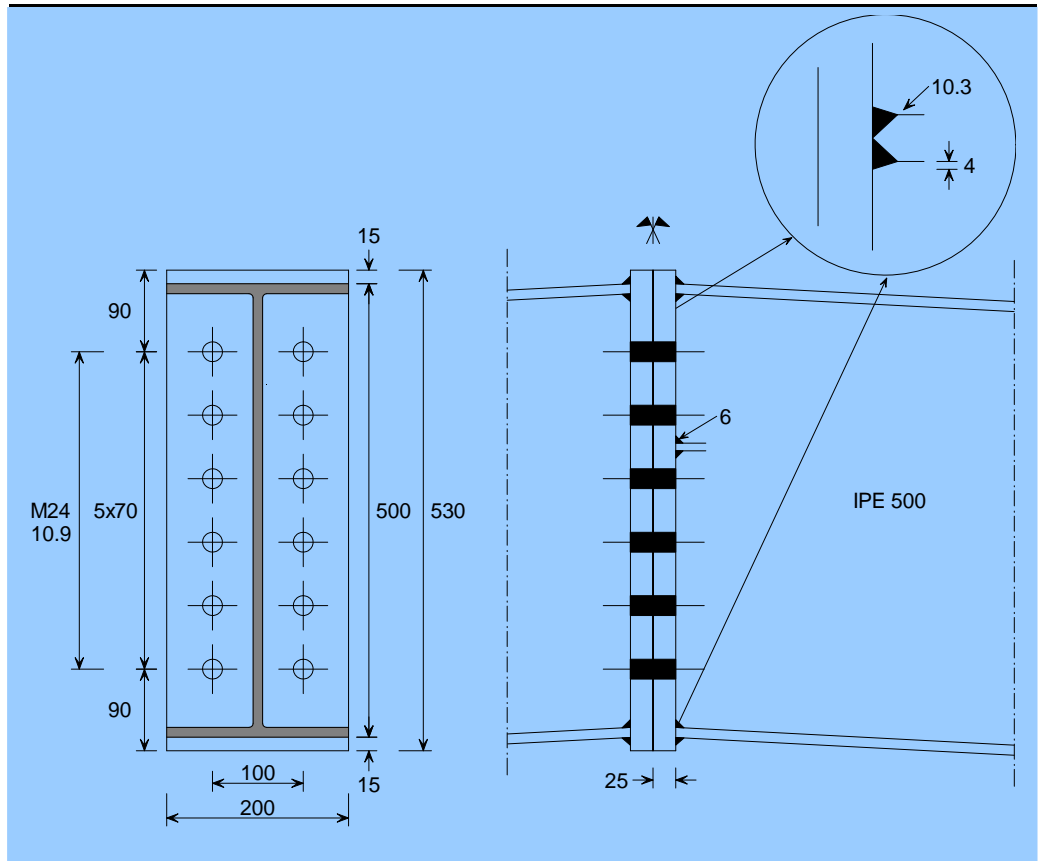

Bolts M24 10.9
 Hole diameter 26 mm
 End plate $t_p = 25$ mm

Beam IPE 500	S235	S275	S355
Positive moment			
Design moment resistance $M_{j,Rd}$ (kNm)	363,1	421,5	479,4
Minimum span length for 'rigid' $L_{b,min}$ (m)		5,62	
Negative moment			
Design moment resistance $M_{j,Rd}$ (kNm)	363,1	421,5	479,4
Minimum span length for 'rigid' $L_{b,min}$ (m)		5,62	
Design axial resistance			
Tension $N_{t,j,Rd}$ (kN)	1404	1642	1839
Compression $N_{c,j,Rd}$ (kN)	2726	3190	4044
Design shear resistance $V_{j,Rd}$ (kN)		474	

Table 4.22 Apex connection – IPE 500

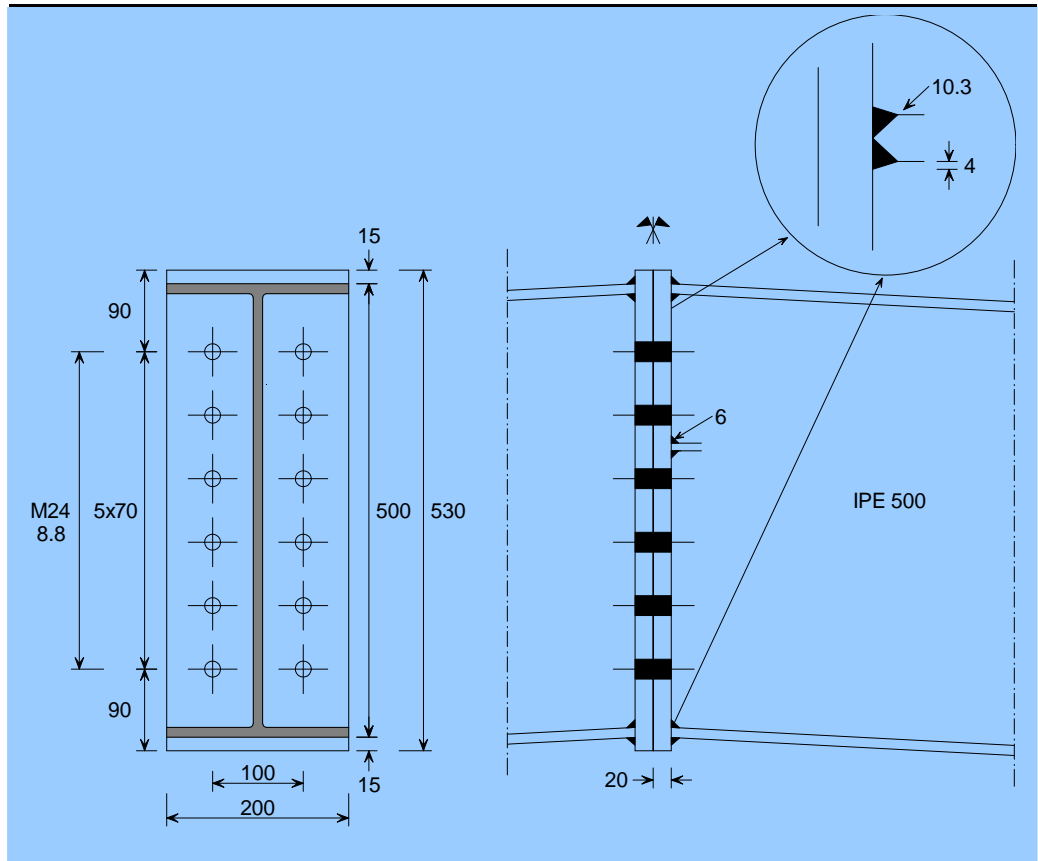

Bolts M24 8.8
 Hole diameter 26 mm
 End plate $t_p = 20$ mm

Beam IPE 500	S235	S275	S355
Positive moment			
Design moment resistance $M_{j,Rd}$ (kNm)	339,9	360,0	360,0
Minimum span length for 'rigid' $L_{b,min}$ (m)		7,18	
Negative moment			
Design moment resistance $M_{j,Rd}$ (kNm)	339,9	360,0	360,0
Minimum span length for 'rigid' $L_{b,min}$ (m)		7,18	
Design axial resistance			
Tension $N_{t,j,Rd}$ (kN)	1404	1445	1691
Compression $N_{c,j,Rd}$ (kN)	2726	3190	4044
Design shear resistance $V_{j,Rd}$ (kN)		455	

Table 4.23 Apex connection – IPE 500

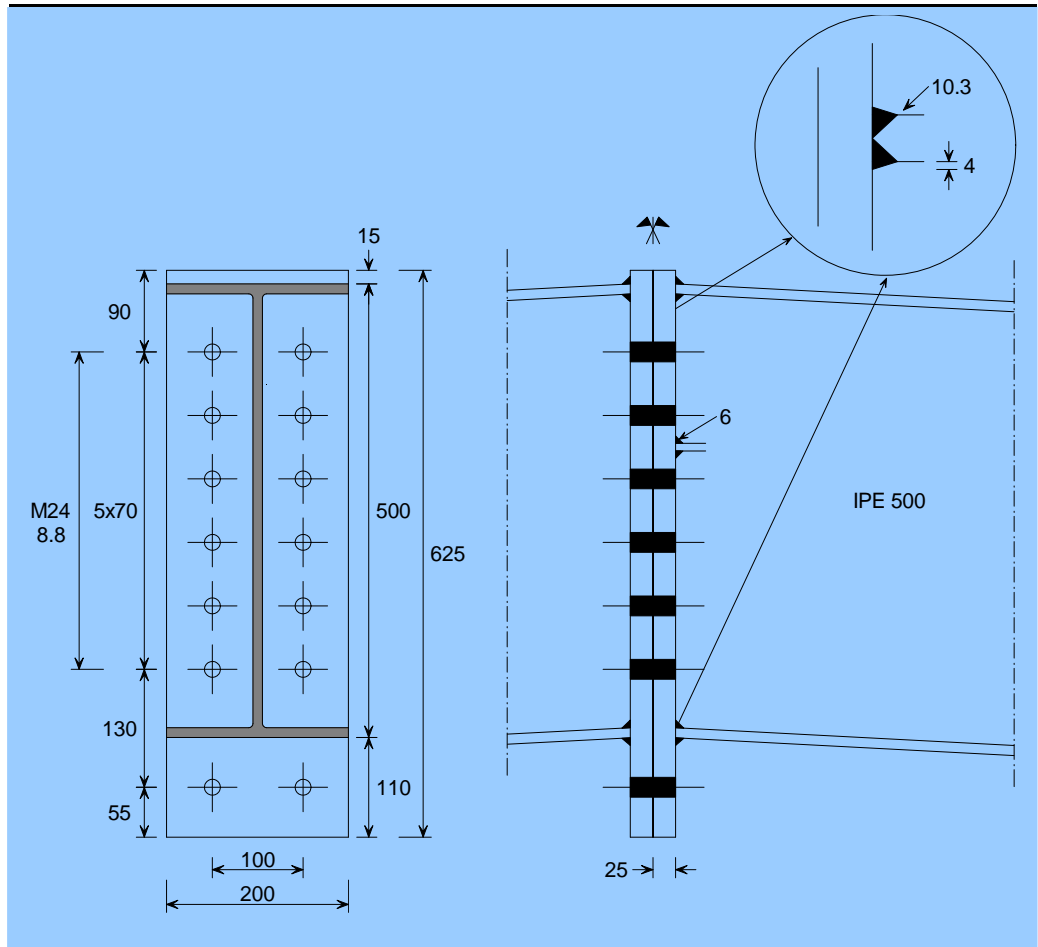

Bolts M24	8.8
Hole diameter	26 mm
End plate	$t_p = 25$ mm

Beam IPE 500	S235	S275	S355
Positive moment			
Design moment resistance $M_{j,Rd}$ (kNm)	448,6	504,8	577,1
Minimum span length for 'rigid' $L_{b,min}$ (m)		3,87	
Negative moment			
Design moment resistance $M_{j,Rd}$ (kNm)	358,1	407,3	426,3
Minimum span length for 'rigid' $L_{b,min}$ (m)		5,62	
Design axial resistance			
Tension $N_{t,j,Rd}$ (kN)	1684	1934	2131
Compression $N_{c,j,Rd}$ (kN)	2726	3190	4044
Design shear resistance $V_{j,Rd}$ (kN)			
		531	

Table 4.24 Apex connection – IPE 500

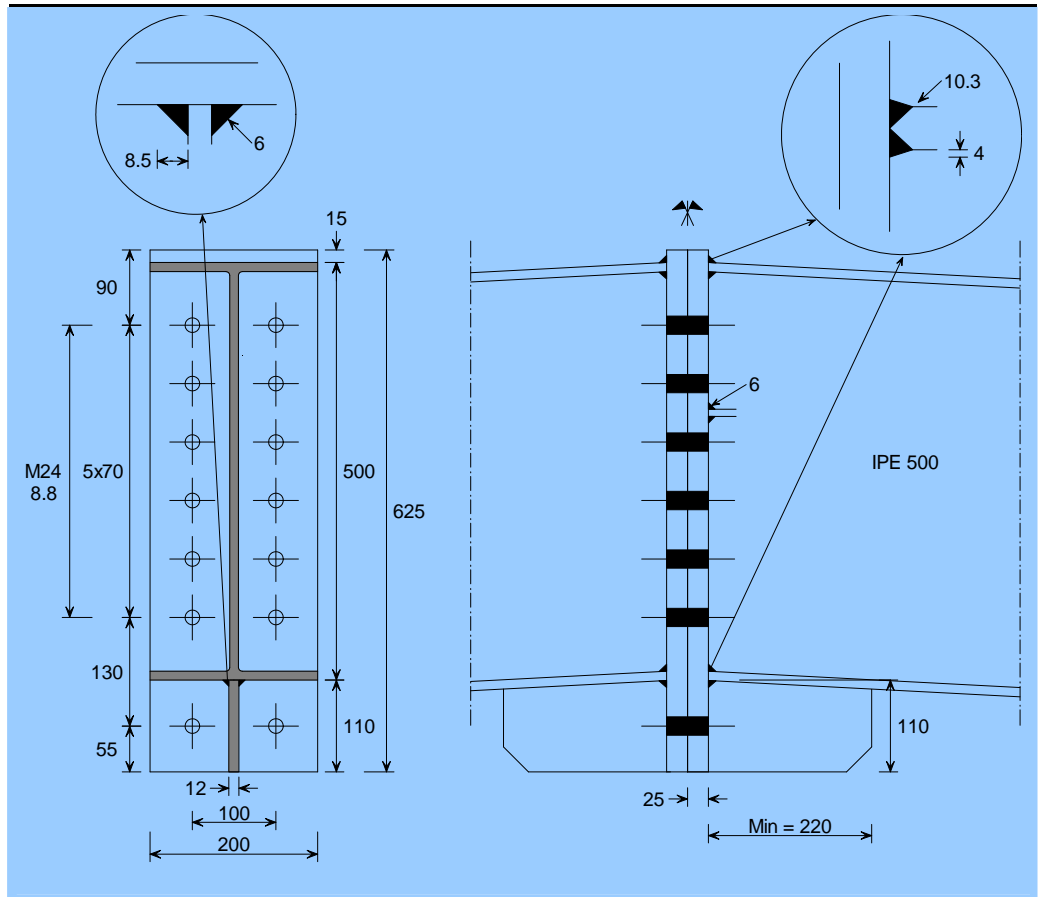

Bolts M24	8.8
Hole diameter	26 mm
End plate	$t_p = 25$ mm
Stiffeners	$t_p = 12$ mm

Beam IPE 500	S235	S275	S355
Positive moment			
Design moment resistance $M_{j,Rd}$ (kNm)	472,4	533,6	620,4
Minimum span length for 'rigid' $L_{b,min}$ (m)		3,03	
Negative moment			
Design moment resistance $M_{j,Rd}$ (kNm)	358,1	407,3	426,3
Minimum span length for 'rigid' $L_{b,min}$ (m)		5,62	
Design axial resistance			
Tension $N_{t,j,Rd}$ (kN)	1775	2041	2238
Compression $N_{c,j,Rd}$ (kN)	2726	3190	4044
Design shear resistance $V_{j,Rd}$ (kN)			
		531	

4.5 Eaves connections

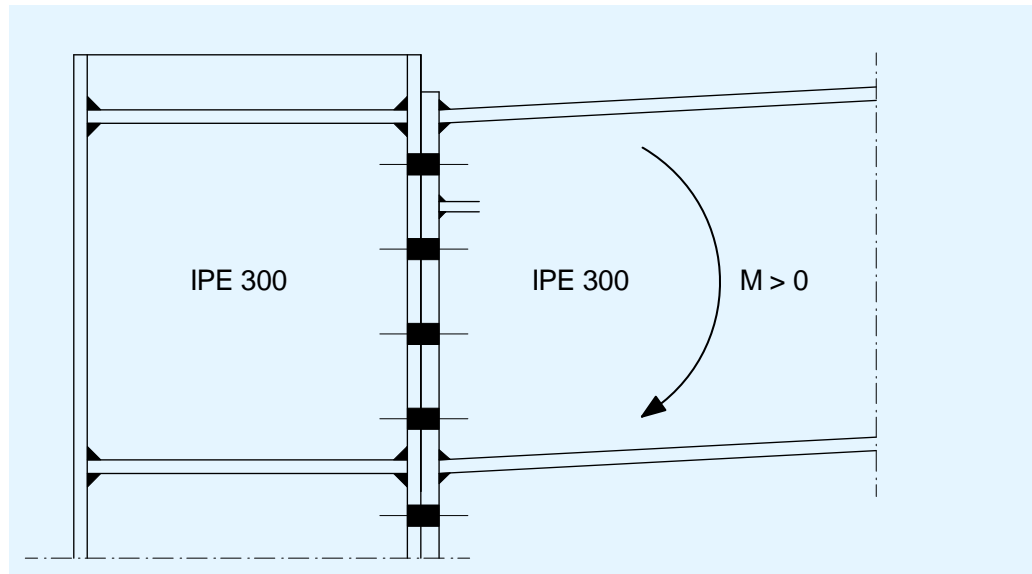
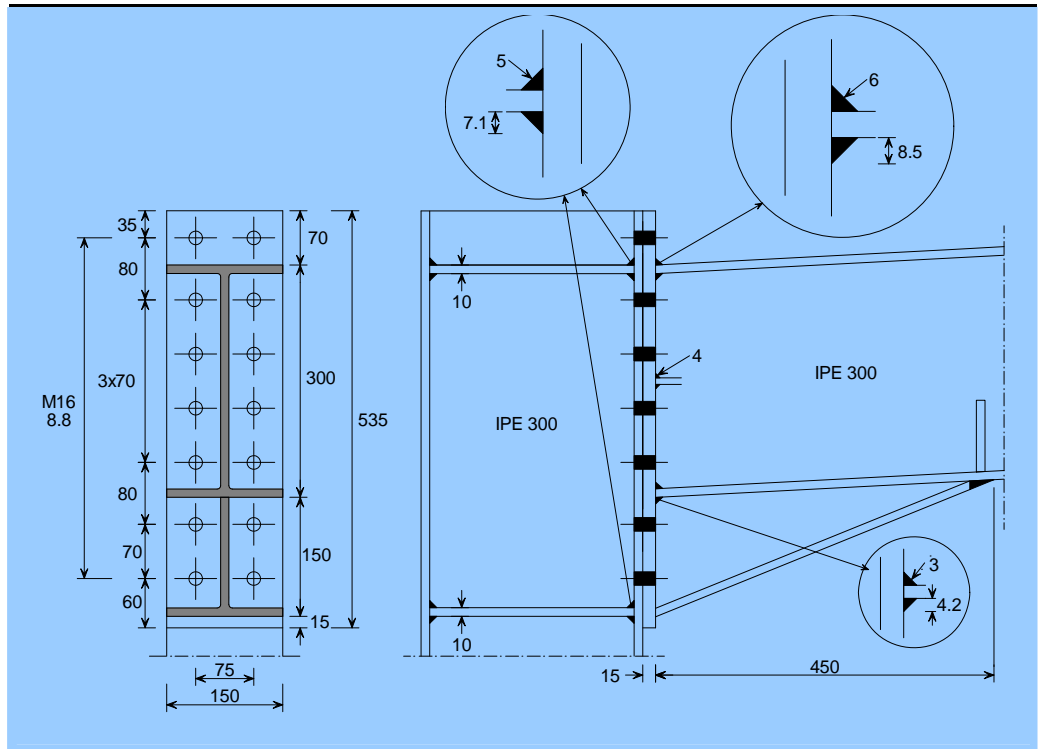

Figure 4.3 Sign convention for bending moment in eaves connections

Table 4.25 Eaves connection – IPE 300



Bolts M16	8.8
Hole diameter	18 mm
Column stiffeners	$t_p = 10$ mm
End plate	$t_p = 15$ mm

Column IPE 300	Beam IPE 300	S235	S275	S355
Positive moment				
Design moment resistance $M_{j,Rd}$ (kNm)		134,7	154,3	187,4
Minimum span length for 'rigid' $L_{b,min}$ (m)			9,03	
Negative moment				
Design moment resistance $M_{j,Rd}$ (kNm)		110,5	124,2	146,6
Minimum span length for 'rigid' $L_{b,min}$ (m)			12,10	
Design axial resistance				
Tension $N_{t,j,Rd}$ (kN)		348	408	526
Compression $N_{c,j,Rd}$ (kN)		348	408	526
Design shear resistance $V_{j,Rd}$ (kN)			236	

Table 4.26 Eaves connection – IPE 300

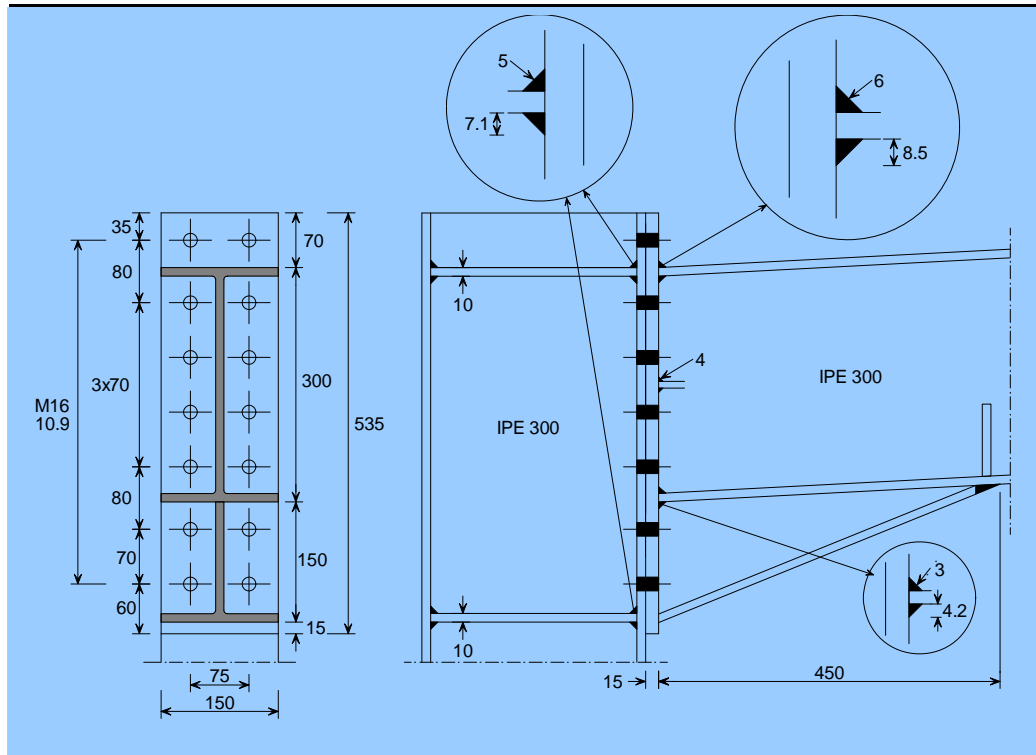

Bolts M16	10.9
Hole diameter	18 mm
Column stiffeners	$t_p = 10$ mm
End plate	$t_p = 15$ mm

Column IPE 300	Beam IPE 300	S235	S275	S355
Positive moment				
Design moment resistance $M_{j,Rd}$ (kNm)		136,4	158,2	197,2
Minimum span length for 'rigid' $L_{b,min}$ (m)			9,03	
Negative moment				
Design moment resistance $M_{j,Rd}$ (kNm)		112,7	130,4	158,8
Minimum span length for 'rigid' $L_{b,min}$ (m)			12,10	
Design axial resistance				
Tension $N_{t,j,Rd}$ (kN)		348	408	526
Compression $N_{c,j,Rd}$ (kN)		348	408	526
Design shear resistance $V_{j,Rd}$ (kN)			246	

Table 4.27 Eaves connection – IPE 300

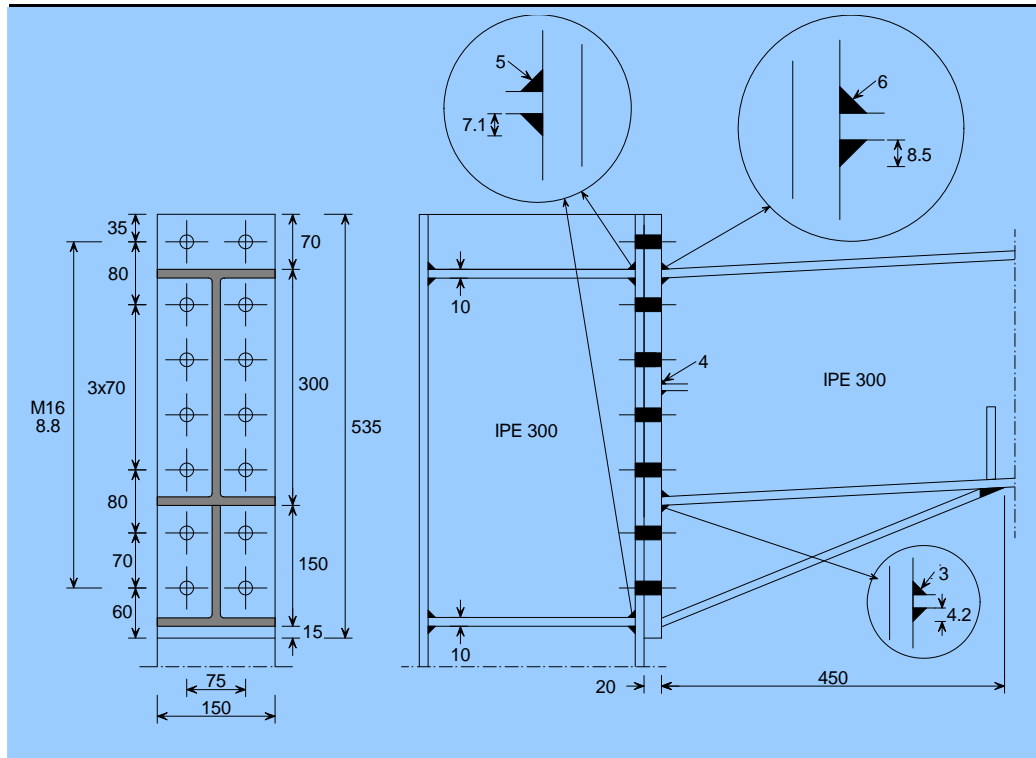

Bolts M16	8.8
Hole diameter	18 mm
Column stiffeners	$t_p = 10$ mm
End plate	$t_p = 20$ mm

Column IPE 300	Beam IPE 300	S235	S275	S355
Positive moment				
Design moment resistance $M_{j,Rd}$ (kNm)		134,7	154,3	189,1
Minimum span length for 'rigid' $L_{b,min}$ (m)			8,91	
Negative moment				
Design moment resistance $M_{j,Rd}$ (kNm)		110,5	124,2	146,6
Minimum span length for 'rigid' $L_{b,min}$ (m)			12,02	
Design axial resistance				
Tension $M_{i,j,Rd}$ (kN)		348	408	526
Compression $N_{c,j,Rd}$ (kN)		348	408	526
Design shear resistance $V_{j,Rd}$ (kN)			236	

Table 4.28 Eaves connection – IPE 300

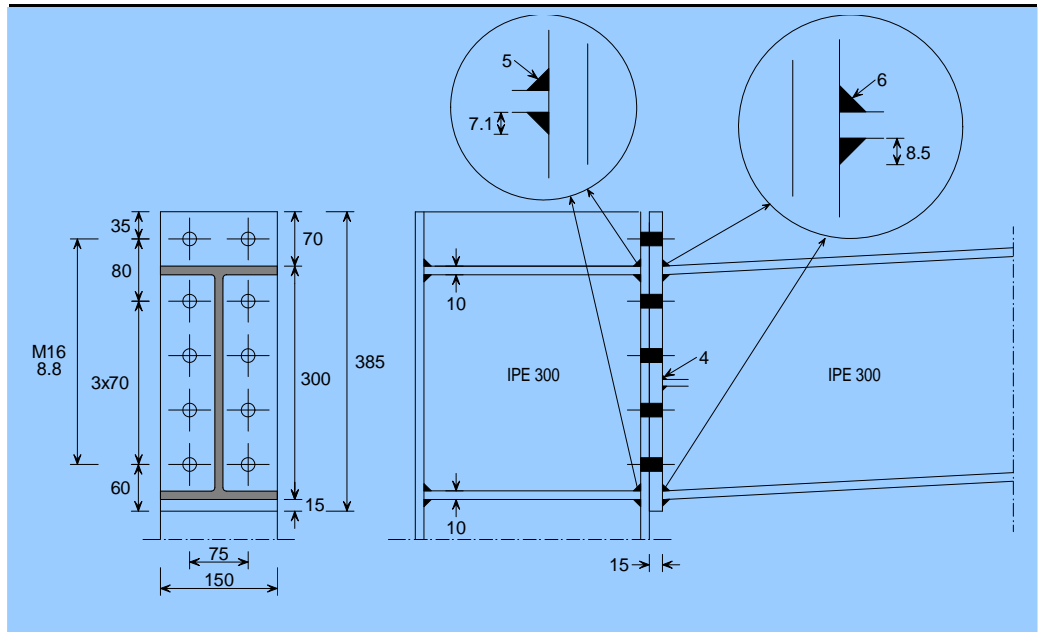

Bolts M16	8.8
Hole diameter	18 mm
Column stiffeners	$t_p = 10$ mm
End plate	$t_p = 15$ mm

Column IPE 300	Beam IPE 300	S235	S275	S355
Positive moment				
Design moment resistance $M_{j,Rd}$ (kNm)		87,4	98,9	113,6
Minimum span length for 'rigid' $L_{b,min}$ (m)			16,65	
Negative moment				
Design moment resistance $M_{j,Rd}$ (kNm)		60,4	63,2	68,9
Minimum span length for 'rigid' $L_{b,min}$ (m)			27,89	
Design axial resistance				
Tension $M_{i,j,Rd}$ (kN)		348	408	526
Compression $N_{c,j,Rd}$ (kN)		348	408	526
Design shear resistance $V_{j,Rd}$ (kN)			176	

Table 4.29 Eaves connection – IPE 300

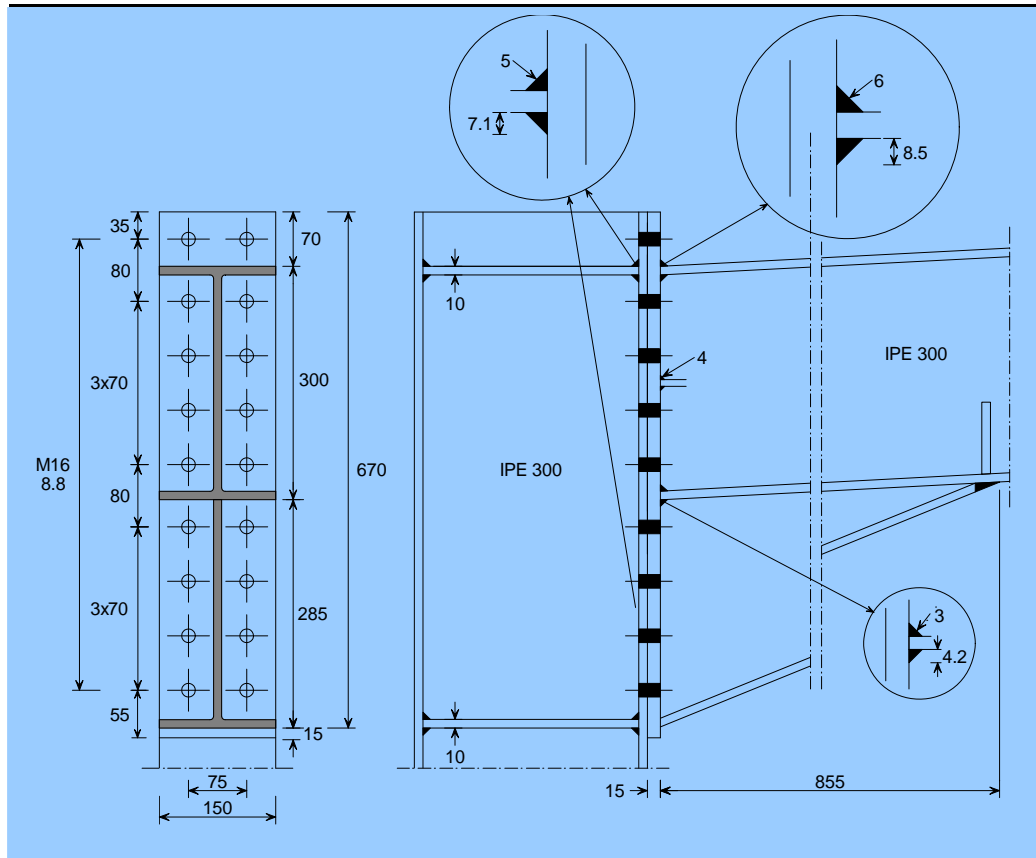

Bolts M16	8.8
Hole diameter	18 mm
Column stiffeners	$t_p = 10$ mm
End plate	$t_p = 15$ mm

Column IPE 300	Beam IPE 300	S235	S275	S355
Positive moment				
Design moment resistance $M_{j,Rd}$ (kNm)		177,2	204,1	251,9
Minimum span length for 'rigid' $L_{b,min}$ (m)			6,31	
Negative moment				
Design moment resistance $M_{j,Rd}$ (kNm)		156,0	178,9	219,0
Minimum span length for 'rigid' $L_{b,min}$ (m)			7,61	
Design axial resistance				
Tension $N_{t,j,Rd}$ (kN)		348	408	526
Compression $N_{c,j,Rd}$ (kN)		348	408	526
Design shear resistance $V_{j,Rd}$ (kN)			317	

Table 4.30 Eaves connection – IPE 400

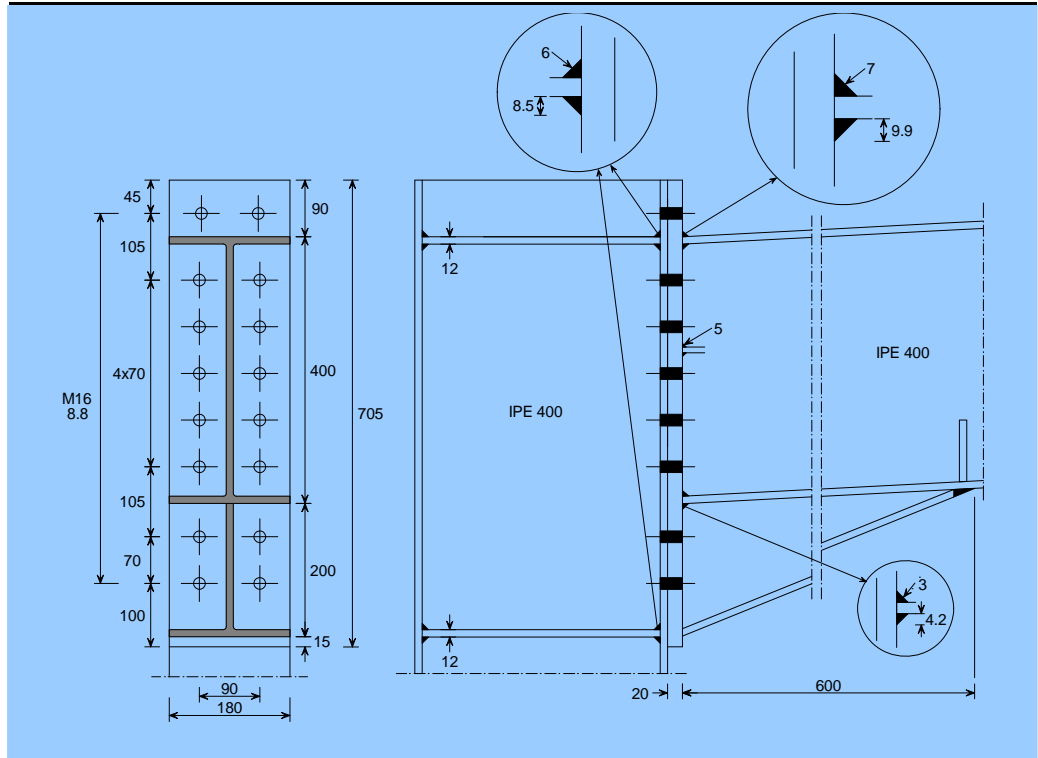

Bolts M20	8.8
Hole diameter	22 mm
Column stiffeners	$t_p = 12$ mm
End plate	$t_p = 20$ mm

Column IPE 400	Beam IPE 400	S235	S275	S355
Positive moment				
Design moment resistance $M_{j,Rd}$ (kNm)		291,2	338,3	417,5
Minimum span length for 'rigid' $L_{b,min}$ (m)			11,53	
Negative moment				
Design moment resistance $M_{j,Rd}$ (kNm)		233,9	263,0	311,8
Minimum span length for 'rigid' $L_{b,min}$ (m)			16,56	
Design axial resistance				
Tension $M_{i,j,Rd}$ (kN)		579	678	875
Compression $N_{c,j,Rd}$ (kN)		579	678	875
Design shear resistance $V_{j,Rd}$ (kN)			421	

Table 4.31 Eaves connection – IPE 400

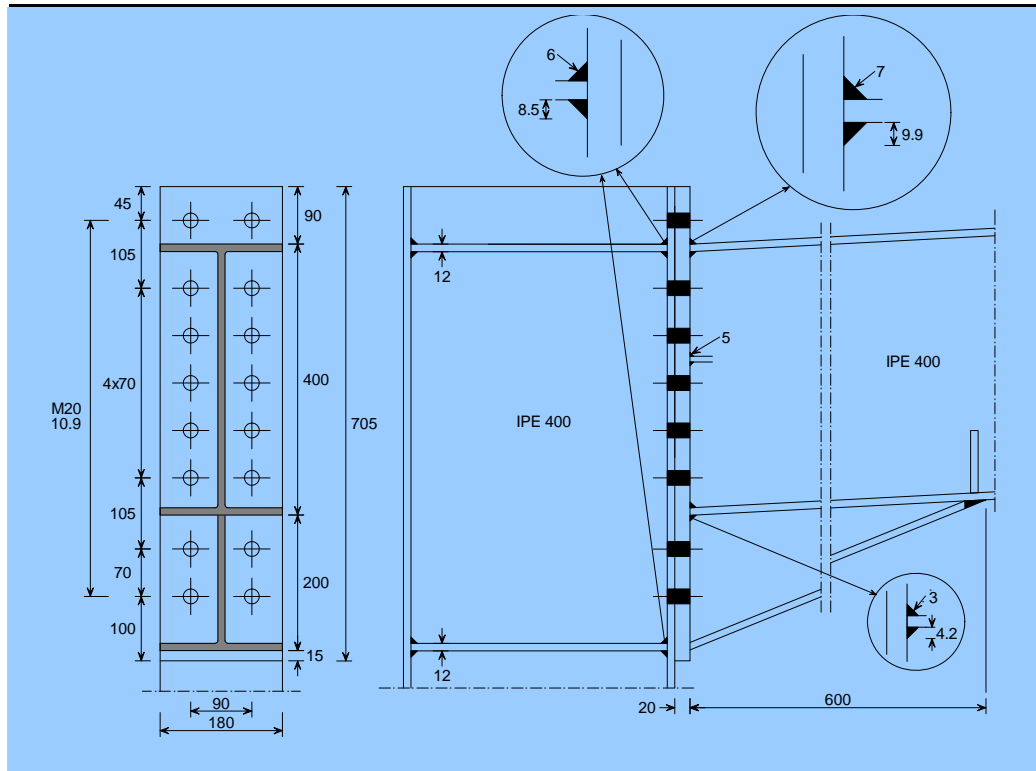

Bolts M20	10.9
Hole diameter	22 mm
Column stiffeners	$t_p = 12$ mm
End plate	$t_p = 20$ mm

Column IPE 400	Beam IPE 400	S235	S275	S355
Positive moment				
Design moment resistance $M_{j,Rd}$ (kNm)		293,9	341,6	435,2
Minimum span length for 'rigid' $L_{b,min}$ (m)			11,53	
Negative moment				
Design moment resistance $M_{j,Rd}$ (kNm)		234,9	274,3	336,5
Minimum span length for 'rigid' $L_{b,min}$ (m)			16,56	
Design axial resistance				
Tension $N_{t,j,Rd}$ (kN)		579	678	875
Compression $N_{c,j,Rd}$ (kN)		579	678	875
Design shear resistance $V_{j,Rd}$ (kN)			439	

Table 4.32 Eaves connection – IPE 400

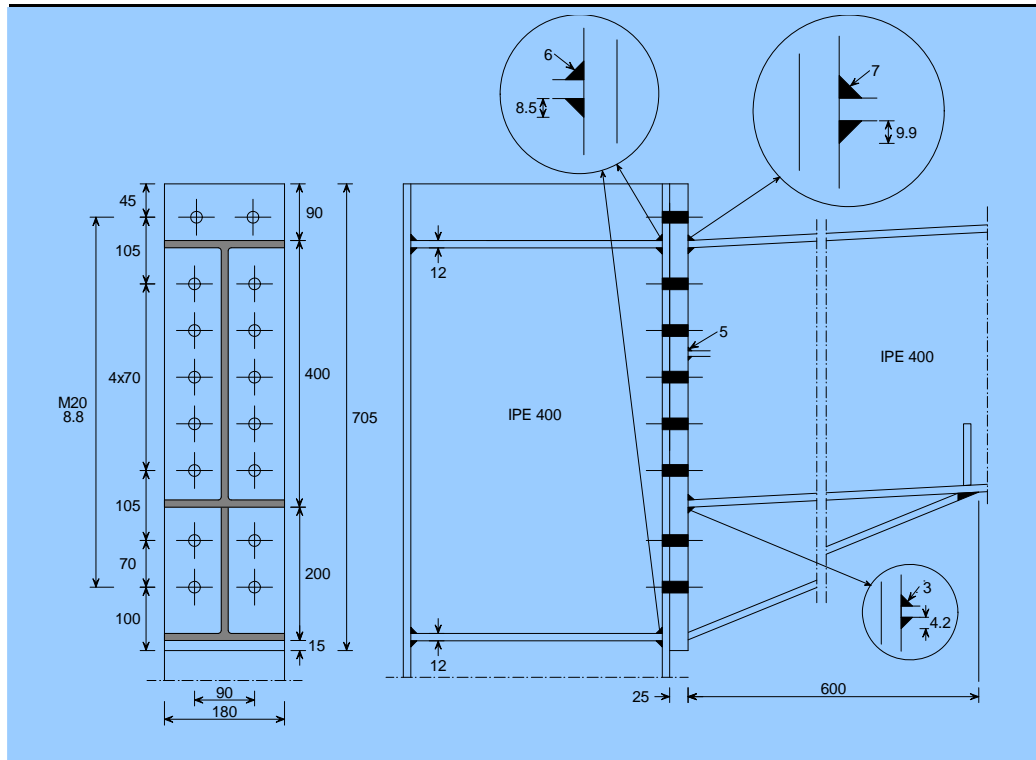

Bolts M20	8.8
Hole diameter	22 mm
Column stiffeners	$t_p = 12$ mm
End plate	$t_p = 25$ mm

Column IPE 400	Beam IPE 400	S235	S275	S355
Positive moment				
Design moment resistance $M_{j,Rd}$ (kNm)		291,2	338,3	420,8
Minimum span length for 'rigid' $L_{b,min}$ (m)			11,41	
Negative moment				
Design moment resistance $M_{j,Rd}$ (kNm)		233,9	263,0	311,8
Minimum span length for 'rigid' $L_{b,min}$ (m)			16,49	
Design axial resistance				
Tension $N_{t,j,Rd}$ (kN)		579	678	875
Compression $N_{c,j,Rd}$ (kN)		579	678	875
Design shear resistance $V_{j,Rd}$ (kN)			421	

Table 4.33 Eaves connection – IPE 400

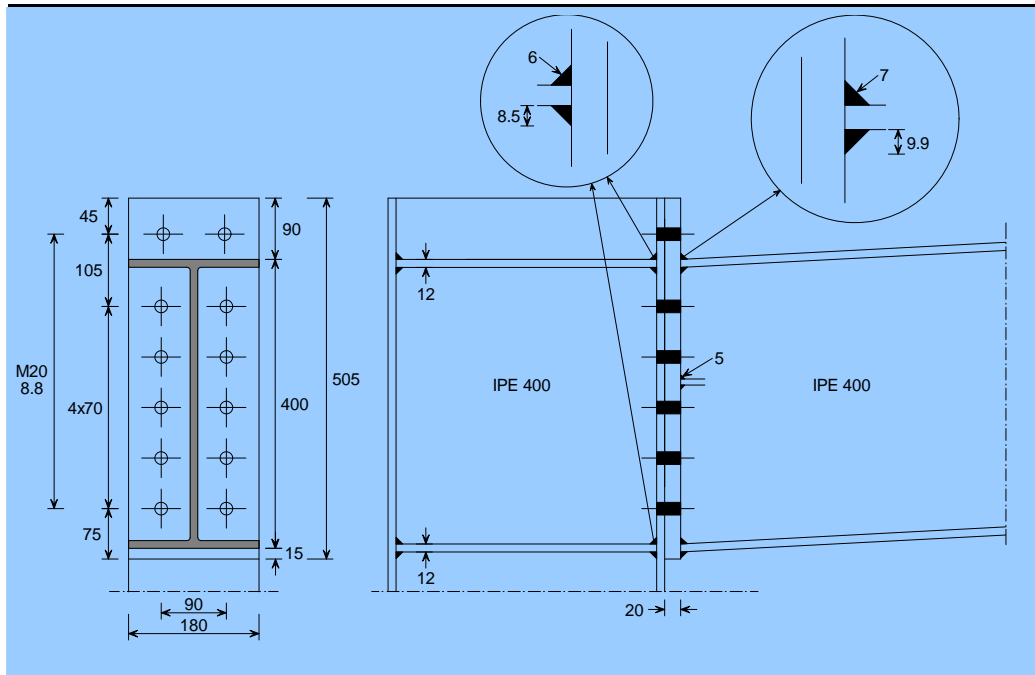

Bolts M20	8.8
Hole diameter	22 mm
Column stiffeners	$t_p = 12$ mm
End plate	$t_p = 20$ mm

Column IPE 400	Beam IPE 400	S235	S275	S355
Positive moment				
Design moment resistance $M_{j,Rd}$ (kNm)		186,6	214,8	258,2
Minimum span length for 'rigid' $L_{b,min}$ (m)			21,58	
Negative moment				
Design moment resistance $M_{j,Rd}$ (kNm)		142,7	160,0	176,5
Minimum span length for 'rigid' $L_{b,min}$ (m)			35,16	
Design axial resistance				
Tension $N_{t,j,Rd}$ (kN)		579	678	875
Compression $N_{c,j,Rd}$ (kN)		579	678	875
Design shear resistance $V_{j,Rd}$ (kN)			316	

Table 4.34 Eaves connection – IPE 400

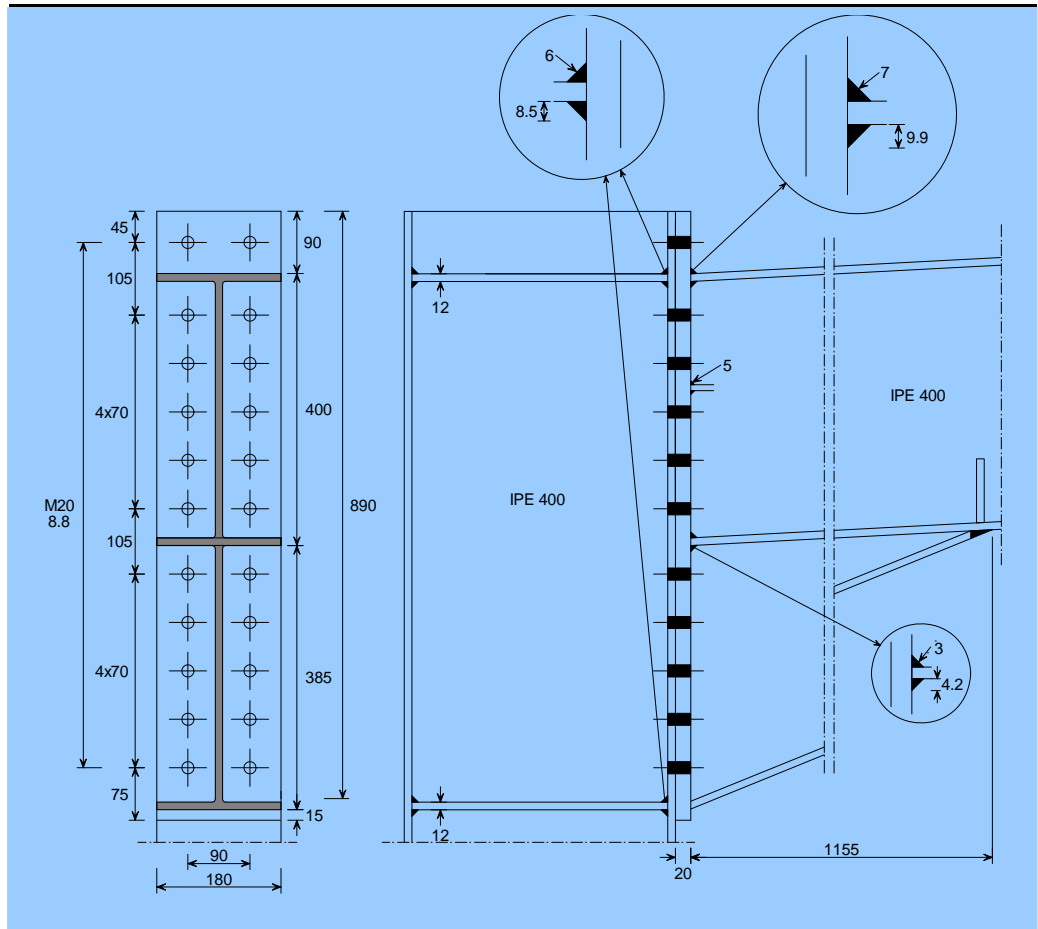

Bolts M20	8.8
Hole diameter	22 mm
Column stiffeners	$t_p = 12$ mm
End plate	$t_p = 20$ mm

Column IPE 400	Beam IPE 400	S235	S275	S355
Positive moment				
Design moment resistance $M_{j,Rd}$ (kNm)		388,0	451,8	564,0
Minimum span length for 'rigid' $L_{b,min}$ (m)			7,95	
Negative moment				
Design moment resistance $M_{j,Rd}$ (kNm)		347,3	400,9	498,3
Minimum span length for 'rigid' $L_{b,min}$ (m)			9,59	
Design axial resistance				
Tension $N_{t,j,Rd}$ (kN)		579	678	875
Compression $N_{c,j,Rd}$ (kN)		579	678	875
Design shear resistance $V_{j,Rd}$ (kN)			580	

Table 4.35 Eaves connection – IPE 500

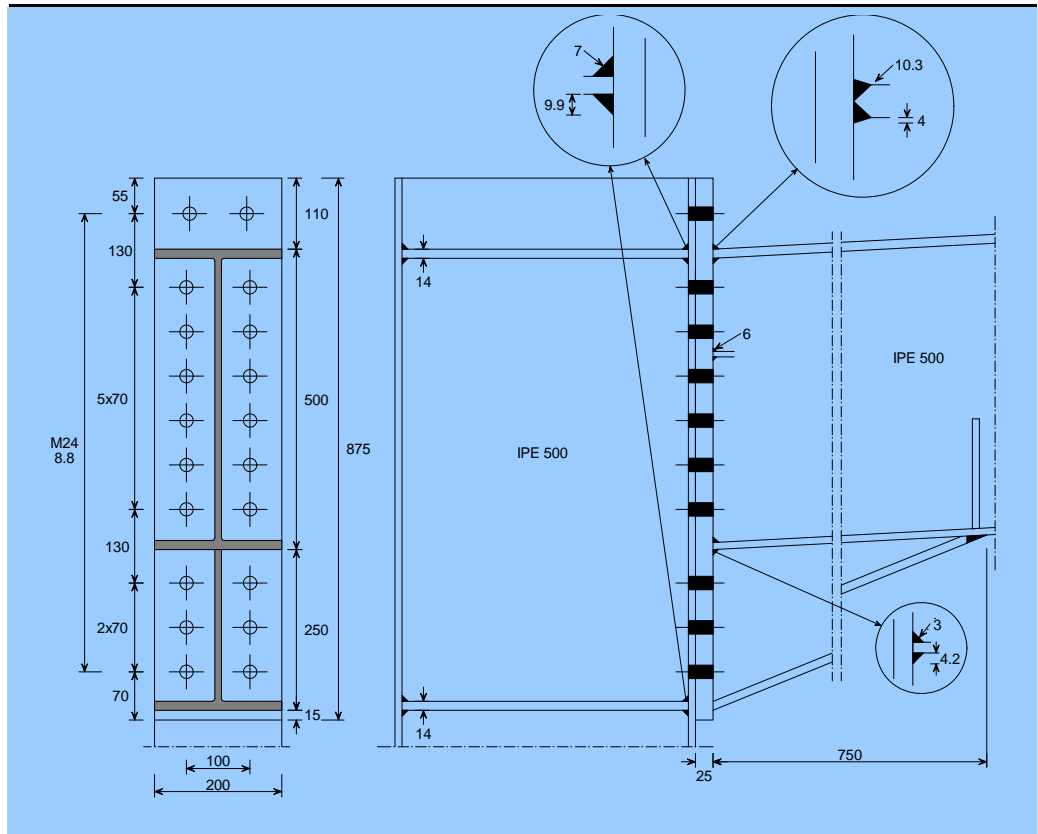

Bolts M24	8.8
Hole diameter	26 mm
Column stiffeners	$t_p = 14$ mm
End plate	$t_p = 25$ mm

Column IPE 500	Beam IPE 500	S235	S275	S355
Positive moment				
Design moment resistance $M_{j,Rd}$ (kNm)		511,0	593,9	739,7
Minimum span length for 'rigid' $L_{b,min}$ (m)			13,80	
Negative moment				
Design moment resistance $M_{j,Rd}$ (kNm)		458,4	529,9	650,5
Minimum span length for 'rigid' $L_{b,min}$ (m)			16,62	
Design axial resistance				
Tension $N_{t,j,Rd}$ (kN)		812	951	1227
Compression $N_{c,j,Rd}$ (kN)		812	951	1227
Design shear resistance $V_{j,Rd}$ (kN)			759	

Table 4.36 Eaves connection – IPE 500

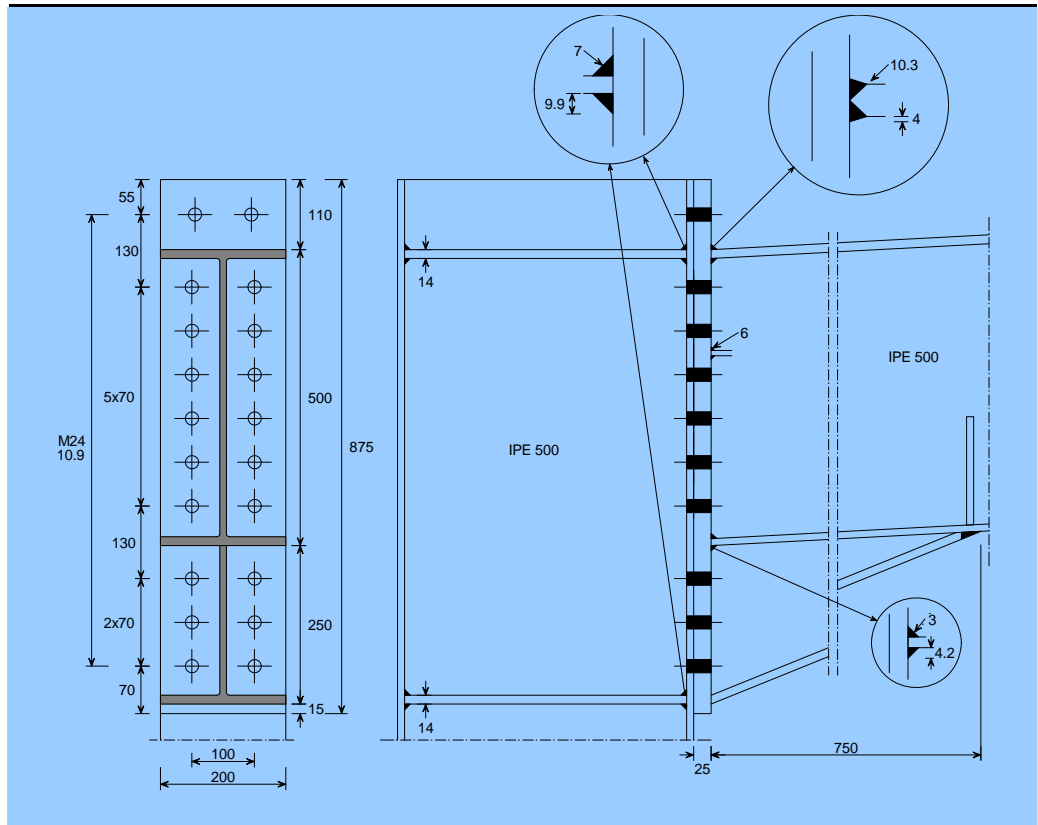

Bolts M24	10.9
Hole diameter	26 mm
Column stiffeners	$t_p = 14$ mm
End plate	$t_p = 25$ mm

Column IPE 500	Beam IPE 500	S235	S275	S355
Positive moment				
Design moment resistance $M_{j,Rd}$ (kNm)		514,9	599,2	763,7
Minimum span length for 'rigid' $L_{b,min}$ (m)			13,80	
Negative moment				
Design moment resistance $M_{j,Rd}$ (kNm)		492,3	537,6	682,1
Minimum span length for 'rigid' $L_{b,min}$ (m)			16,62	
Design axial resistance				
Tension $N_{t,j,Rd}$ (kN)		812	951	1227
Compression $N_{c,j,Rd}$ (kN)		812	951	1227
Design shear resistance $V_{j,Rd}$ (kN)			791	

Table 4.37 Eaves connection – IPE 500

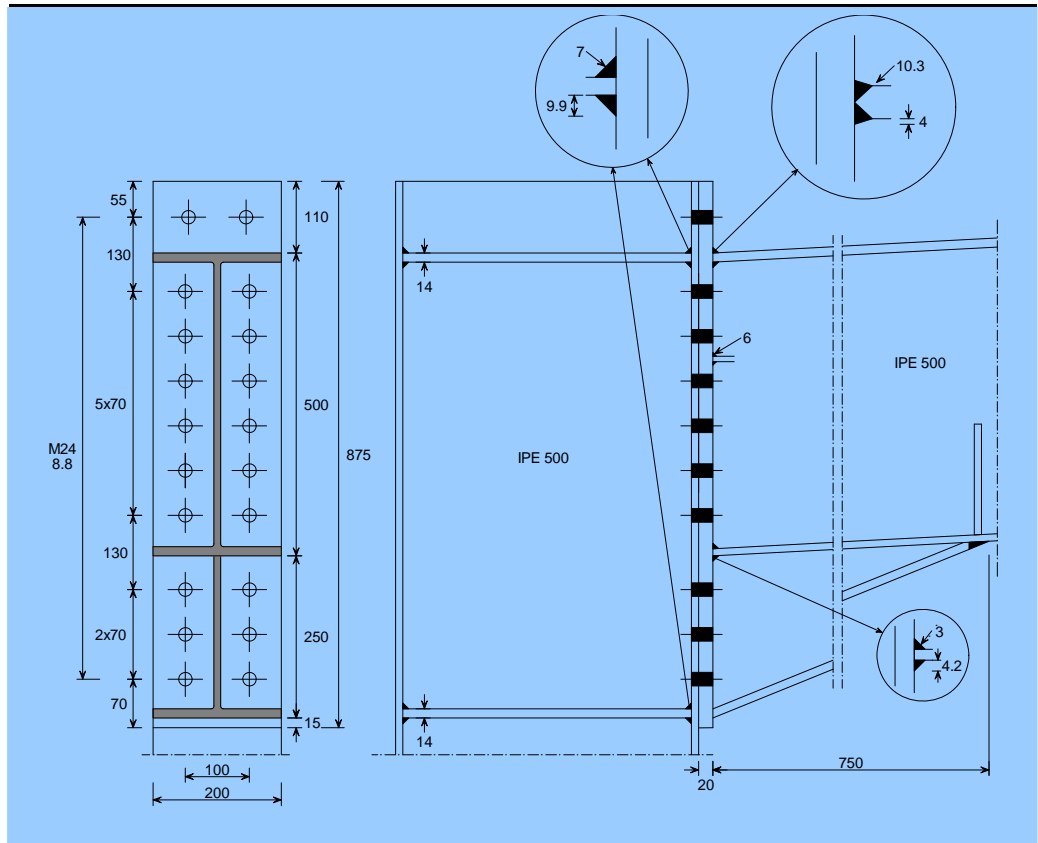

Bolts M24	8.8
Hole diameter	26 mm
Column stiffeners	$t_p = 14$ mm
End plate	$t_p = 20$ mm

Column IPE 500	Beam IPE 500	S235	S275	S355
Positive moment				
Design moment resistance $M_{j,Rd}$ (kNm)		500,2	580,9	716,4
Minimum span length for 'rigid' $L_{b,min}$ (m)			14,17	
Negative moment				
Design moment resistance $M_{j,Rd}$ (kNm)		458,4	529,9	650,5
Minimum span length for 'rigid' $L_{b,min}$ (m)			16,77	
Design axial resistance				
Tension $N_{t,j,Rd}$ (kN)		812	951	1227
Compression $N_{c,j,Rd}$ (kN)		812	951	1227
Design shear resistance $V_{j,Rd}$ (kN)			759	

Table 4.38 Eaves connection – IPE 500

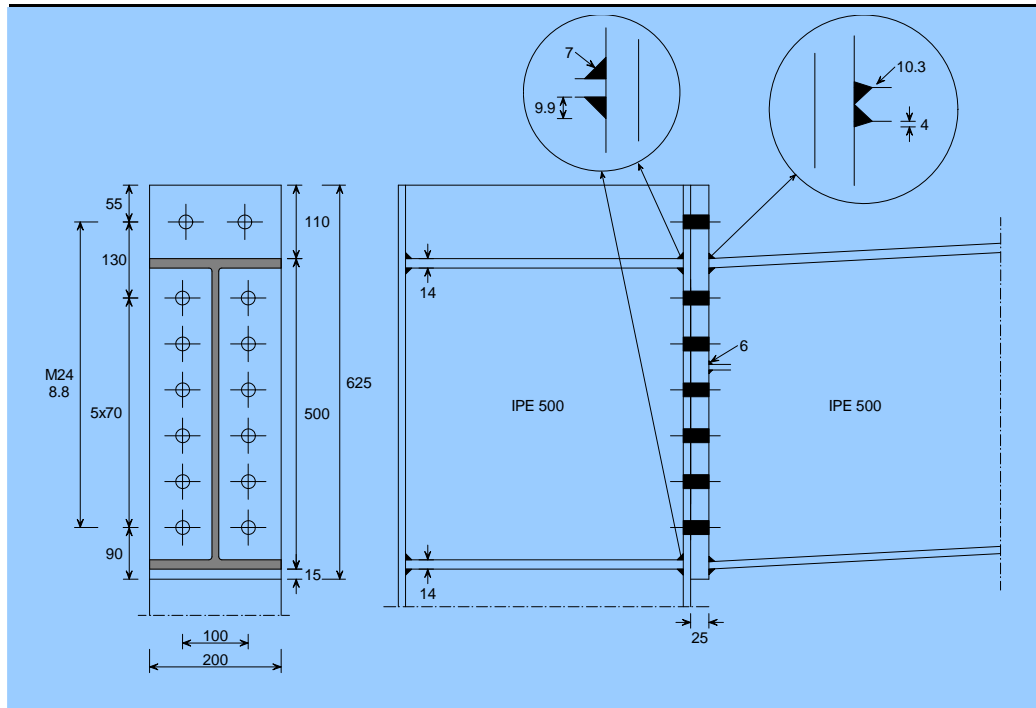

Bolts M24	8.8
Hole diameter	26 mm
Column stiffeners	$t_p = 14$ mm
End plate	$t_p = 25$ mm

Column IPE 500	Beam IPE 500	S235	S275	S355
Positive moment				
Design moment resistance $M_{j,Rd}$ (kNm)		327,8	379,0	462,3
Minimum span length for 'rigid' $L_{b,min}$ (m)			25,97	
Negative moment				
Design moment resistance $M_{j,Rd}$ (kNm)		258,4	297,9	353,7
Minimum span length for 'rigid' $L_{b,min}$ (m)			40,84	
Design axial resistance				
Tension $N_{t,j,Rd}$ (kN)		812	951	1227
Compression $N_{c,j,Rd}$ (kN)		812	951	1227
Design shear resistance $V_{j,Rd}$ (kN)			531	

Table 4.39 Eaves connection – IPE 500

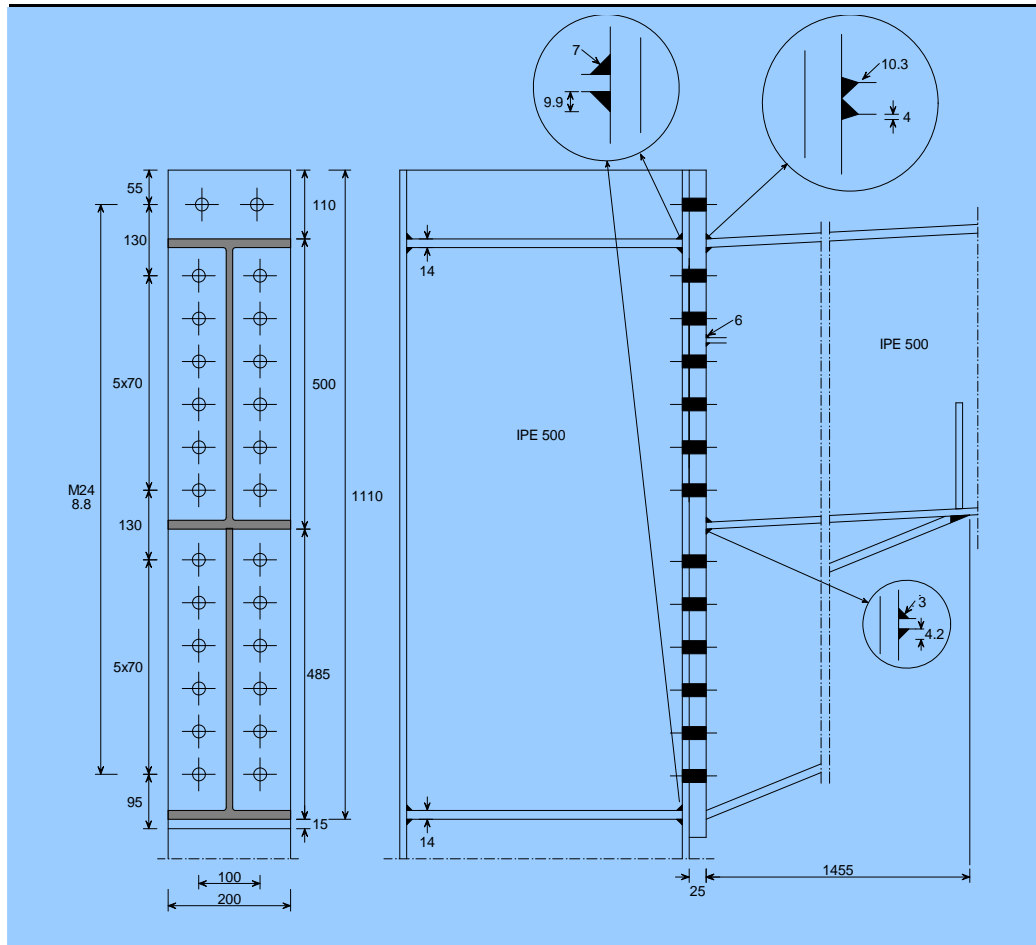

Bolts M24	8.8
Hole diameter	26 mm
Column stiffeners	$t_p = 14$ mm
End plate	$t_p = 25$ mm

Column IPE 500	Beam IPE 500	S235	S275	S355
Positive moment				
Design moment resistance $M_{j,Rd}$ (kNm)		683,3	795,8	1000
Minimum span length for 'rigid' $L_{b,min}$ (m)			9,45	
Negative moment				
Design moment resistance $M_{j,Rd}$ (kNm)		612,8	712,6	899,3
Minimum span length for 'rigid' $L_{b,min}$ (m)			11,28	
Design axial resistance				
Tension $N_{t,j,Rd}$ (kN)		812	951	1227
Compression $N_{c,j,Rd}$ (kN)		812	951	1227
Design shear resistance $V_{j,Rd}$ (kN)			987	

REFERENCES

- 1 EN 1993-1-8: Eurocode 3 Design of steel structures. Joint design